



APPENDICES

Integrated Transport and Access Plan - Cardno

**Environmental Wind Assessment - 115B Victoria Parade
& Young Street Carpark - ARUP**

**Arboricultural Impact Assessment Reprt - Simone Howe
of John Patrick Landscape Architects**



Integrated Transport and Access Plan

Australian Catholic University, St. Patricks Campus, Fitzroy

Prepared for Australian Catholic University
27 October 2016



Document Information

Prepared for Australian Catholic University
 Project Name Australian Catholic University, St. Patricks Campus, Fitzroy
 File Reference CG150178REP001F03.docx
 Job Reference CG150178
 Date 27 October 2016

Contact Information

Cardno Victoria Pty Ltd
 Trading as **Cardno**
 ABN 47 106 610 913

Level 4
 501 Swanston Street
 Melbourne
 Victoria 3000 Australia

Telephone: (03) 8415 7777
 Facsimile: (03) 8415 7788
 International: +61 3 8415 7777

victoria@cardno.com.au
 www.cardno.com

Document Control

Version	Date	Author	Author Initials	Reviewer	Reviewer Initials
F03	27/10/16	Sam Mulligan	SM	John-Paul Maina	JPM
F02	16/03/16	John-Paul Maina	-	-	-
F01	8/02/16	Luke Richardson	-	John-Paul Maina	-
D01	27/11/15	Luke Richardson	-	John-Paul Maina	-

© Cardno. Copyright in the whole and every part of this document belongs to Cardno and may not be used, sold, transferred, copied or reproduced in whole or in part in any manner or form or in or on any media to any person other than by agreement with Cardno.

This document is produced by Cardno solely for the benefit and use by the client in accordance with the terms of the engagement. Cardno does not and shall not assume any responsibility or liability whatsoever to any third party arising out of any use or reliance by any third party on the content of this document.

Table of Contents

1	Introduction	5
1.1	Background	5
1.2	Purpose	6
2	Existing Conditions	7
2.1	Population and Employment	7
2.2	Mode Share and Journey to Work	7
2.3	Pedestrian Network	8
2.4	Bicycle Network	10
2.5	Public Transport	11
2.6	Traffic Network	14
2.7	Road Network Safety	21
2.8	Car Parking	22
3	State and Local Policies	23
3.1	State Policies	23
3.2	Local Policy	25
4	Development Proposal	27
4.1	Development Plan	27
4.2	Individual Projects	27
5	Transport Network Interventions	28
5.1	Pedestrian Network	28
5.2	Bicycle Network	28
5.3	Local Area Traffic Management	29
6	Statutory Considerations	30
6.1	Schedule 2 to the Development Plan Overlay	30
6.2	Design Response	30
6.3	Car Parking - Clause 52.06	32
6.4	Bicycle Parking – Clause 52.34	32
7	Traffic Impact	33
7.1	Projected Traffic Volumes	33
7.2	Traffic Distribution	35
7.3	Post Development Traffic Flows	35
7.4	Intersection Analysis	36
8	Green Travel Initiatives	37
8.1	Preamble	37
8.2	Objective	37
8.3	Action Plan (Guide Only)	37
8.4	Monitoring and Review	38
9	Conclusions	40

Appendices

Appendix A Concept Functional Layout Plans

Appendix B Bicycle Parking Products

1 Introduction

1.1 Background

A Development Plan is being prepared for the Australian Catholic University (ACU) St Patrick's Campus to deliver a mixed use development to accommodate the planned growth in students, teachers and research activities, improve the quality of teaching and learning environments and improve the pedestrian and public environments for students and the wider community.

To accompany the Development Plan, Cardno was engaged by Australian Catholic University to prepare an Integrated Transport and Access Plan (ITAP). The subject site comprises a number of buildings generally located to the north of Victoria Street between Brunswick Street and Napier Street, as shown in Figure 1-1.

The site is located within the suburb of Fitzroy and is situated approximately 500 metres to the east of the Melbourne Central Activities District (CAD).

Figure 1-1 Site Location

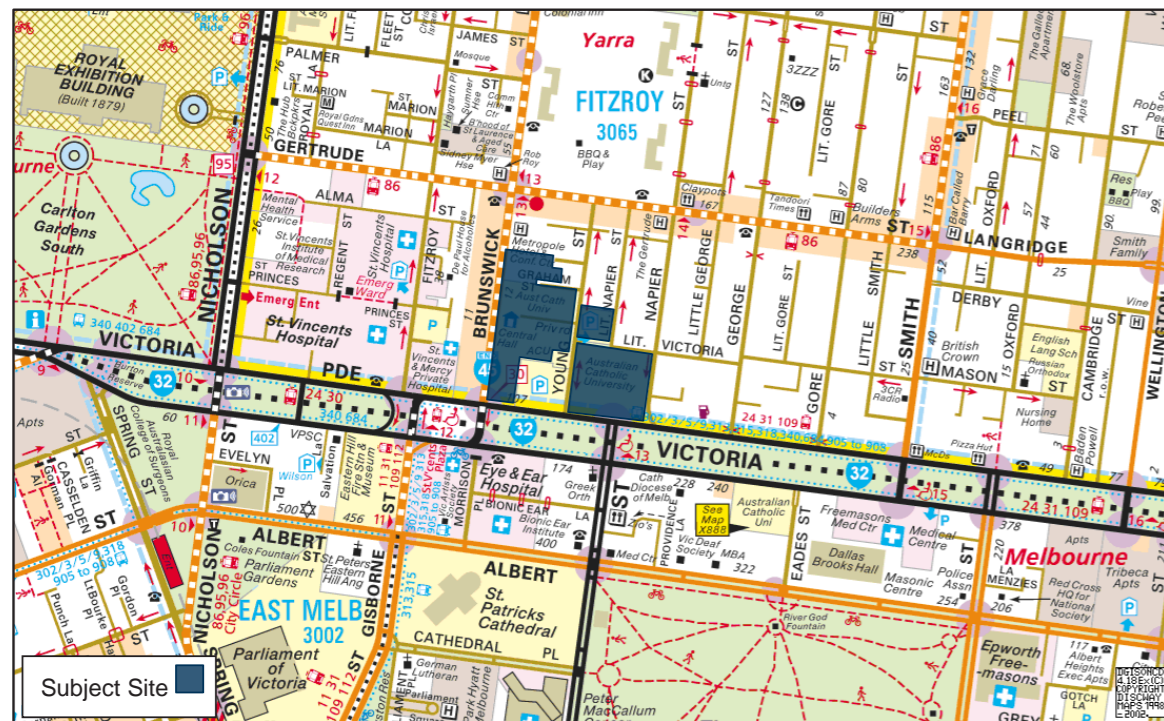

Schedule 2 to the Development Plan Overlay (DPO) (or Schedule 2 to Clause 43.04 of the Yarra Planning Scheme) applies to the subject site and provides criteria for any future use and development of the land at 115 Victoria Parade and 20-23 Brunswick Street, Fitzroy.

Schedule 2 to the DPO is dated 19 January 2006 and provides the following requirements for the Development Plan which are considered relevant to transport:

- > The development plan must show:
 - The number, location, dimensions and layout of all car parks and access ways to and from them;
 - A management plan for the operation and maintenance of the car park areas;
 - The location and dimensions of all bicycle, vehicle and pedestrian ways;
 - A traffic management plan which must show any traffic management and traffic control works considered necessary in adjoining and nearby roads when the development is completed; and
 - The means of vehicular and pedestrian ingress to and egress from the land.

1.2 Purpose

The purpose of this report is to provide an integrated transport approach to any future use and development at ACU.

This report considers all modes of transport, with a view to updating and incorporating a more integrated transport approach to the transport related requirements in Schedule 2 to the DPO.

2 Existing Conditions

2.1 Population and Employment

ACU currently operates with 10,000 effective full time (EFT) students and approximately 800 staff.

2.2 Mode Share and Journey to Work

Relevant journey to work and journey to education data has been sourced from the 2011 ABS Census and the Victorian Integrated Survey of Travel and Activity (VISTA) which is an ongoing survey of travel and activity that helps the government make better transport and land-use planning decisions.

Table 2-1 shows journey to work data based on work destinations for the suburb of Fitzroy from the 2011 ABS Census and for the City of Yarra from the VISTA 09 surveys.

Table 2-1 Journey to Work Data Based on Work Destination

Travel Mode	2011 ABS Census Suburb of Fitzroy	VISTA 09 City of Yarra
Car Based	53%	57%
Public Transport	32%	30%
Bicycle/Walking	15%	13%

Table 2-2 shows journey to education data based on education destinations for RMIT in Melbourne and the Kangan Institute of TAFE in Cremorne. The results are noticeably different, with significantly higher public transport use at RMIT and higher car and bicycle/walking use at Kangan Institute of TAFE.

Table 2-2 Journey to Education Data Based on Education Destination

Travel Mode	VISTA09 RMIT, Melbourne City of Melbourne	VISTA 09 Kangan Institute of TAFE, Cremorne City of Yarra
Car Based	10%	37%
Public Transport	67%	30%
Bicycle/Walking	23%	33%

The site is more similarly located to RMIT with respect to its public transport accessibility and proximity to the CAD, however on-site parking at ACU is more readily available.

In this respect, it is anticipated that car use would be in between the results for RMIT and Kangan Institute of TAFE.

This is confirmed by results from a questionnaire survey that was distributed by ACU staff in May and August 2009.

Approximately 800 surveys were completed and returned, with the results of the survey summarised in Table 2-3, Table 2-4 and Table 2-5 overleaf.

The data collected by the University reveals that a large contingent of the existing student and staff population either catch public transport or walk or cycle to the facility.

Table 2-3 Student Travel Modes

Travel Mode	Number	Percentage
Car (Driver)	122	19%
Car (Passenger)	38	6%
Public Transport	445	68%
Walked	31	5%
Cycled	17	2%
Total	653	100%

Table 2-4 Staff Travel Modes

Travel Mode	Number	Percentage
Car (Driver)	62	34%
Car (Passenger)	12	7%
Public Transport	80	44%
Walked	15	8%
Cycled	8	4%
Other	3	2%
Total	180	100%

Table 2-5 University Travel Modes

Travel Mode	Number	Percentage
Car (Driver)	184	22%
Car (Passenger)	50	6%
Public Transport	525	63%
Walked	46	6%
Cycled	25	3%
Other	3	0%
Total	833	100%

2.3 Pedestrian Network

The existing pedestrian network in the vicinity of the site includes footpaths on both sides of Brunswick Street, Young Street and Napier Street providing access towards Gertrude Street and Victoria Street to the north and south respectively, both of which are also provided with footpaths along both sides.

Victoria Street is also provided with footpaths along both sides of the central median.

Pedestrian crossings are provided at all signalised intersections, including:

- > Brunswick Street / Gertrude Street;
- > Brunswick Street / Victoria Street / Gisborne Street; and
- > Victoria Street / Lansdowne Street.

At all other intersections, pedestrian crossings are facilitated by pram ramps.

Tram stops associated with tram routes 11, 30, 86, 109 and 120 are readily accessible from the subject site via the pedestrian network, whilst Parliament Train Station is also readily accessible via footpaths along both sides of Gisborne Street.

The pedestrian network in the vicinity of the site also provides access towards neighbouring suburbs, including Collingwood, Fitzroy North, Carlton, East Melbourne and the Central Activities District (CAD).

Key pedestrian links in the vicinity of the site is shown graphically in Figure 2-1, whilst Figure 2-2 shows the pedestrian links within the campus and their connections to the key pedestrian links.

Figure 2-1 Key Pedestrian Links



Figure 2-2 Campus Pedestrian Links



2.4 Bicycle Network

The subject site is well serviced by Melbourne's extensive bicycle network, with numerous off-road paths, on-road bicycle lanes and informal bicycle routes (generally designated by painted bicycle symbols and the provision of bicycle storage boxes at signalised intersections).

As shown in Figure 2-3, on-road bicycle lanes on Brunswick Street provide access towards Fitzroy North to the north and towards the CAD to the south via Gisborne Street.

The informal route along Gertrude Street provides access towards Collingwood to the east and towards Carlton to the west via the off-road path between the Royal Exhibition Building and the Melbourne Museum.

Additional on-road bicycle lanes along key streets, including Napier Street, Albert Street, Clarendon Street and Wellington Street provide further connections to surrounding suburbs, including East Melbourne and Richmond.

Figure 2-3 Existing Bicycle Network

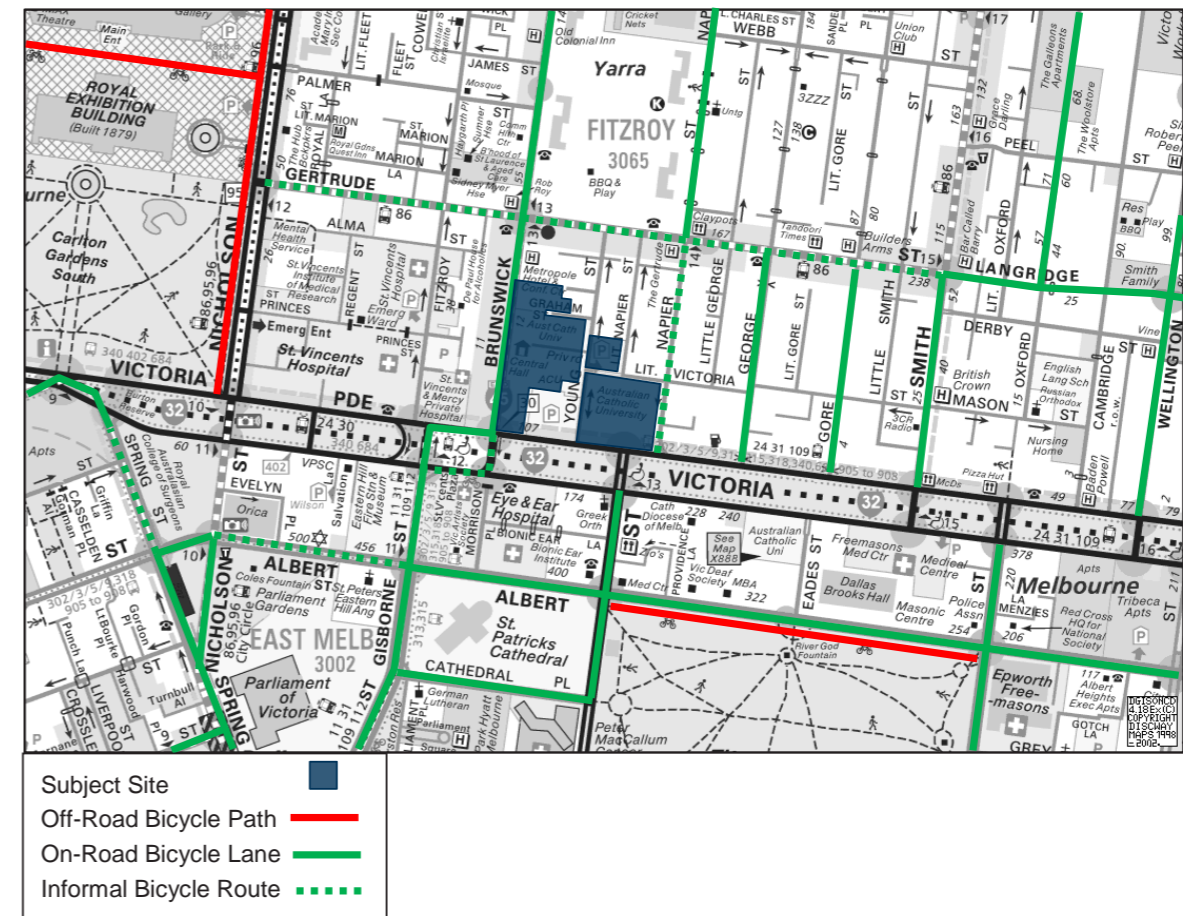

It is noted that to improve safety for cyclists that traverse between Napier Street and Lansdowne Street, new traffic signals have been installed on the departure side (eastbound) of the Victoria Parade / Lansdowne Street intersection.

Council have also recently installed bike share pods along Napier Street, proximate to its intersection with Victoria Parade, and we understand that they also plan to install an additional bike share pod at the Fitzroy Town Hall.

2.5 Public Transport

The subject site has excellent access to public transport, with all train lines accessible via Parliament Station approximately 550 metres walking distance from the subject site and numerous bus and tram routes operating either along the site frontage or in close proximity to the subject site.

The St Vincents Plaza / Victoria Parade tram stop and the Australian Catholic University / Victoria Parade bus stop are located directly adjacent to the site and provide access to a total of 4 tram routes and 11 bus routes. Parliament Station is also accessible via tram routes 11, 12 and 109 which are serviced by the abovementioned St Vincents Plaza / Victoria Parade tram stop.

Tram lines along Victoria Street, Nicholson Street and Gisborne Street are separated from the traffic lanes, whilst the tram lines along Gertrude Street, Brunswick Street and Smith Street are shared with a traffic lane.

Notably, bus lanes have recently been installed along Victoria Parade to provide bus priority through this corridor. It is also understood that plans are being progressed to upgrade the Brunswick Street tram corridor, with the works including the provision of DDA compliant stops.

The public transport services in the vicinity of the site are summarised in Table 2-6 and illustrated graphically in Figure 2-4.

Figure 2-4 Public Transport Map

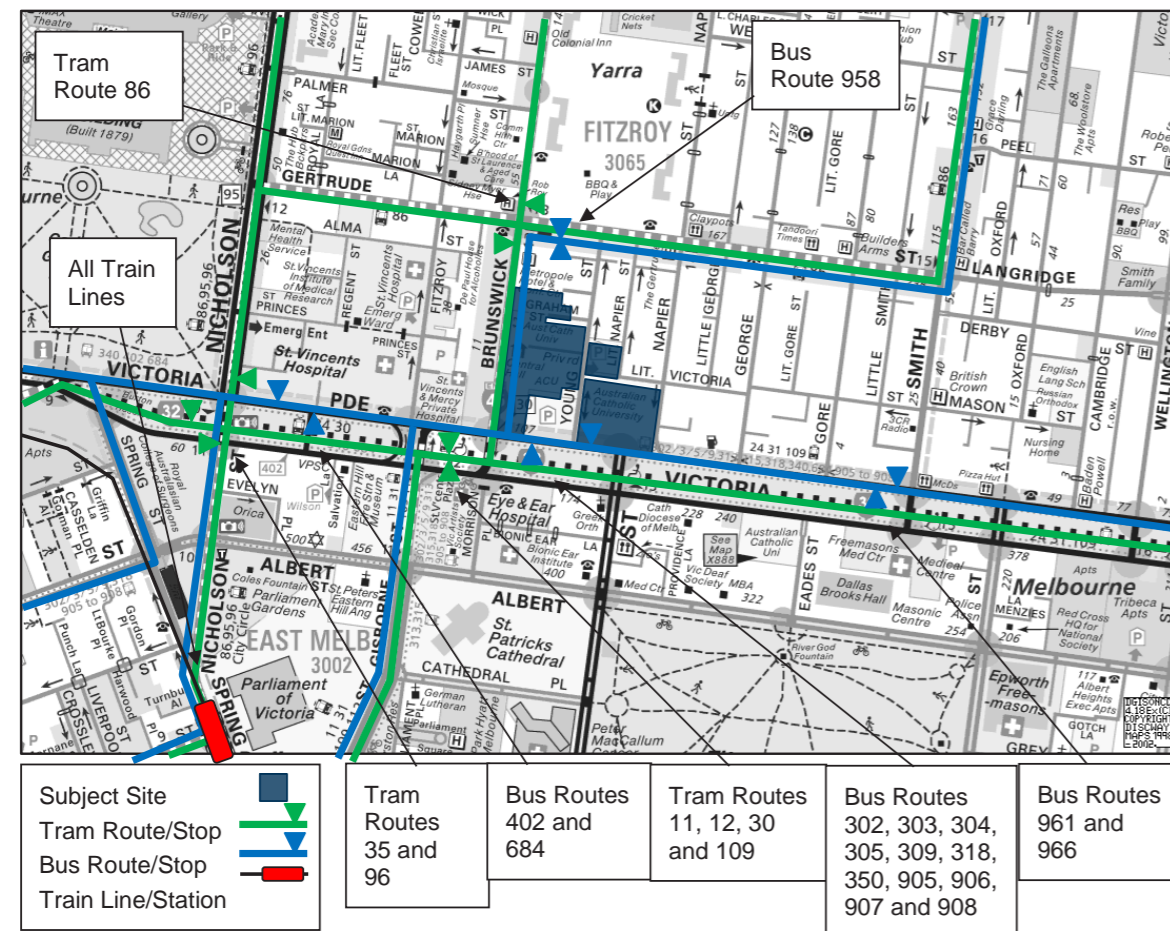
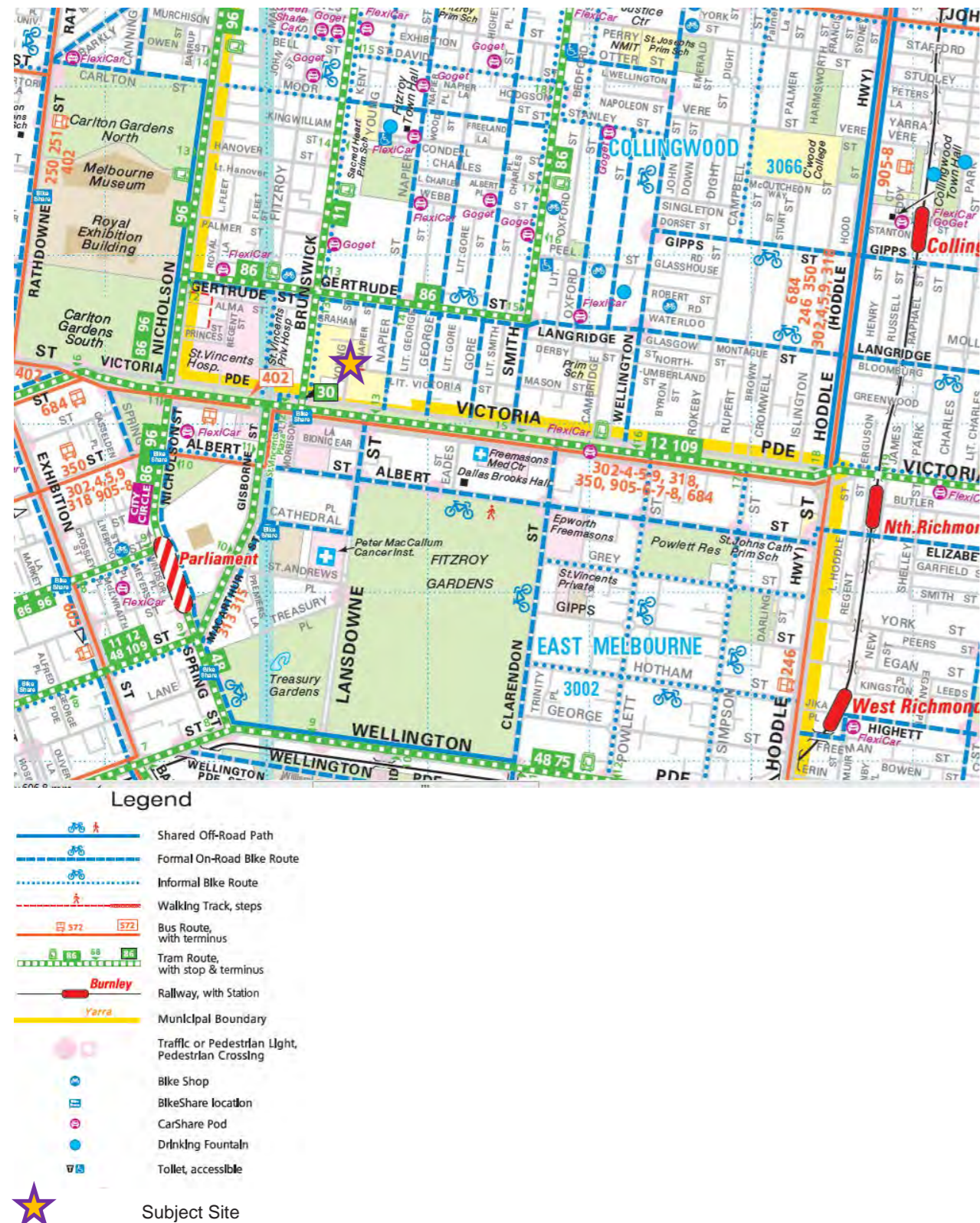

Table 2-6 Public Transport Services

Service	Route No's	Route	Nearest Stop	Approximate Walking Distance		
Tram	11	West Preston – Victoria Harbour Docklands	St Vincents Plaza/Victoria Pde	Adjacent Site		
	12	Victoria Gardens – St Kilda				
	30	St Vincents Plaza – Docklands via La Trobe St				
	109	Box Hill – Port Melbourne				
	86	Bundoora RMIT – Waterfront City Docklands	Brunswick St/Gertrude St	100 m		
	35	City Circle (Free Tourist Tram)	Nicholson St/Victoria Pde	300 m		
96	East Brunswick – St Kilda Beach					
Bus	302	Box Hill via Belmore Rd and Eastern Fwy	Australian Catholic University / Victoria Pde	Adjacent Site		
	303	City – Ringwood North via Park Rd				
	304	City – Doncaster SC via Belmore Rd and Eastern Fwy				
	305	City – The Pines SC via Eastern Fwy				
	309	City – Donvale via Reynolds Rd				
	318	City – Deep Creek				
	350	City – La Trobe University via Eastern Fwy				
	905	City – The Pines SC via Eastern Fwy, Templestowe (SMARTBUS Service)				
	906	City – Warrandyte via The Pines SC (SMARTBUS Service)				
	907	City – Mitcham via Doncaster Road (SMARTBUS Service)				
	908	City – The Pines SC via Eastern Fwy (SMARTBUS Service)				
	402	Footscray – East Melbourne via North Melbourne			St Vincents Hospital / Victoria Pde	200 m
	684	Eildon – Melbourne via Lilydale Station				
	958	NightRider – City – Eltham via Smith Street, Darebin Road			Brunswick St / Gertrude St	100 m
961	NightRider – City – Doncaster via Eastern Freeway, James Street	Smith St / Victoria Pde	300 m			
966	NightRider – City – Croydon – Lilydale via Victoria Street, Maroondah Highway					
Train	All Train Lines		Parliament Station	550 m		

A consolidated public transport and bicycle network plan is provided as Figure 2-5 overleaf.

Figure 2-5 Public Transport and Bicycle Network



2.6 Traffic Network

2.6.1 General

The subject site is primarily accessible via Victoria Parade and Young Street. Various additional crossovers and roller doors provide secondary access, generally for loading and other authorised vehicles.

The key road links in the vicinity of the site are shown in Figure 2-6, providing access to surrounding suburbs including Collingwood and Richmond to the east, Fitzroy North to the north, Carlton and the CAD to the west and East Melbourne to the south.

Both the Eastern Freeway and CityLink are readily accessible from Hoddle Street via Victoria Parade. A detailed review of the streets in the immediate vicinity of the site is provided in the following sections.

Figure 2-6 Key Road Links in the Vicinity of the Site

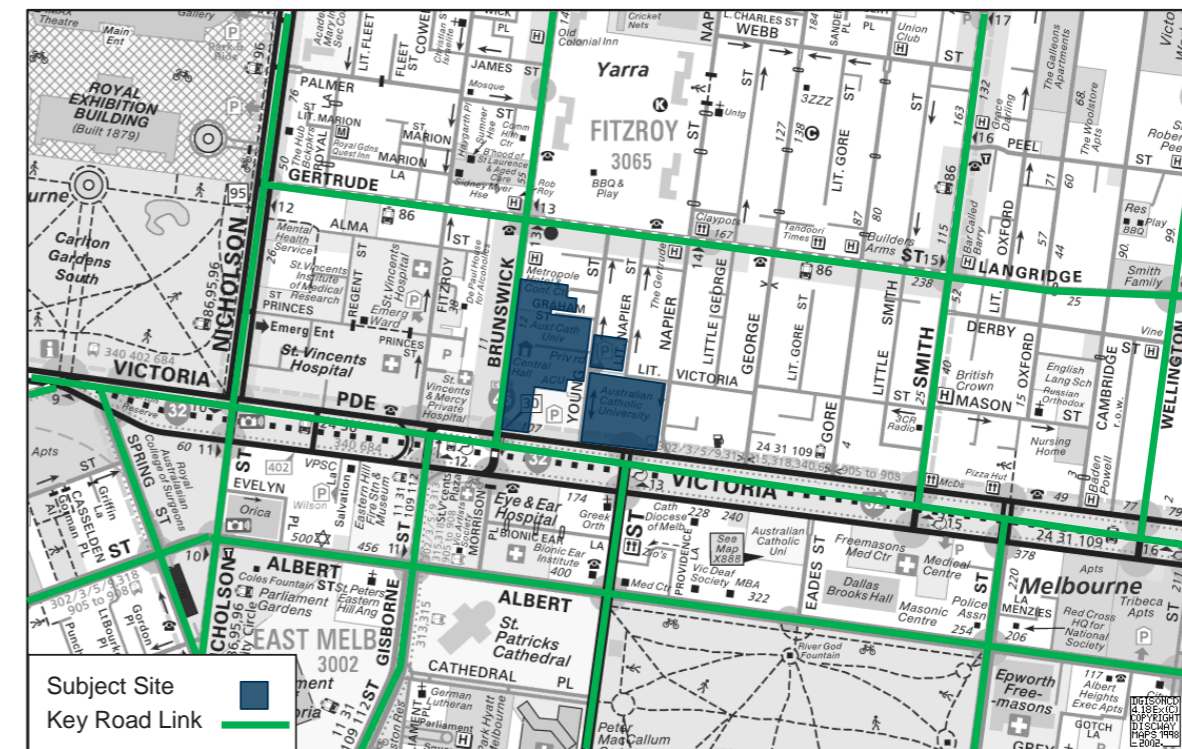

2.6.2 Brunswick Street

Brunswick Street is generally aligned in a north-south direction from St Georges Road in Fitzroy North to Victoria Parade in Fitzroy. North of Alexandra Parade, Brunswick Street is a Declared Main Road. ACU is located on the east side of Brunswick Street.

Adjacent the subject site, Brunswick Street operates with two lanes in each direction, with the central lanes shared between tram lines and traffic and the kerbside lanes generally operate as shared parking and bicycle lanes, with the exception of between 7:00am – 9:00am Monday to Friday when 'No Stopping' restrictions apply on the eastern kerb.

Both the Brunswick Street / Gertrude Street and Brunswick Street / Victoria Parade intersections are controlled by traffic signals.

In the vicinity of the site, Brunswick Street operates with a posted speed limit of 40 kilometres per hour. A view of Brunswick Street in the vicinity of the site is provided in Figure 2-7.

Figure 2-7 Cross Section of Brunswick Street in the Vicinity of the Site



2.6.3 Young Street

Young Street is a local road aligned in a north-south direction from Gertrude Street to Victoria Parade. Young Street primarily serves an access function, with speed humps used along its length for traffic calming purposes. ACU is located on both the east and west sides of Young Street, with vehicle access provided to an ACU car park and an ACU private road named Duke Street.

Along its length, Young Street operates with a varying cross section. Between Victoria Parade and the entrance to the ACU car park, Young Street operates with a single traffic lane in each direction. This section of Young Street operates with a posted speed limit of 40 kilometres per hour. Beyond this point, Young Street operates as one way, northbound only.

Between Little Victoria Street and Duke Street, Young Street operates as a shared zone, within a carriageway which allows for a single lane of northbound traffic. As required for shared zones, this section of Young Street operates with a speed limit of 10 kilometres per hour. There is generally no provision for kerbside parking, with the exception of a single indented parallel disabled car space.

Between Duke Street and Graham Street, Young Street operates with a single northbound traffic lane, with no provision for kerbside parking. North of the shared zone, Young Street operates with a default speed limit of 50 kilometres per hour.

Between Graham Street and Gertrude Street, Young Street allows for a single lane of northbound traffic, with kerbside parallel parking permitted on the west kerb clear of traffic.

The Young Street / Victoria Parade intersection operates as a left in/left out 'Give Way' controlled T-intersection, with priority given to Victoria Parade.

The Young Street / Gertrude Street intersection operates as a 'Stop' controlled T-intersection, with priority given to Gertrude Street and allows for outbound movements out of Young Street only. Right turns are banned between 7:00am – 9:00am Monday to Friday.

The various cross sections of Young Street are shown in Figure 2-8 through to Figure 2-11.

Figure 2-8 Cross Section of Young Street Between Victoria Parade and ACU Car Park Entrance



Figure 2-9 Cross Section of Young Street Between ACU Car Park Entrance and Duke Street



Figure 2-10 Cross Section of Young Street Between Duke Street and Graham Street



Figure 2-11 Cross Section of Young Street Between Graham Street and Gertrude Street

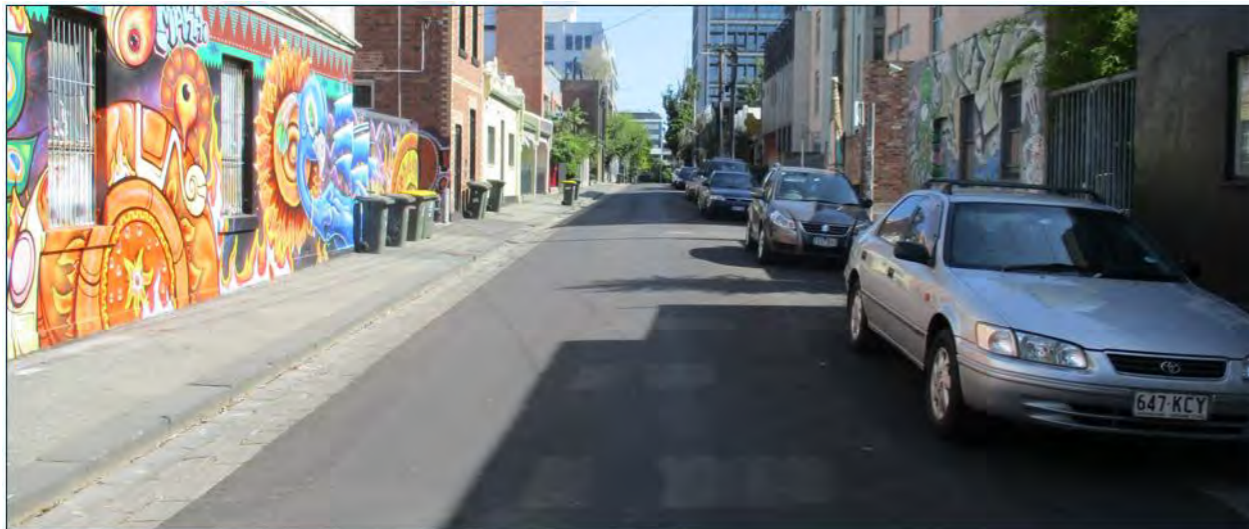

2.6.4 Napier Street

Napier Street is a local road aligned in a north-south direction from Cecil Street to Victoria Parade. Various traffic calming treatments are used along the length of Napier Street, including speed humps and no through roads. ACU is located on the west side of Napier Street. No vehicle access to ACU is provided via Napier Street.

In the vicinity of the site, Napier Street allows for a single lane of traffic in each direction, with angle parking permitted alongside one kerb and parallel parking permitted on the other kerb and a bicycle symbol identifying Napier Street in the vicinity of the site as an informal bicycle route.

The Napier Street / Gertrude Street intersection operates as a 'Stop' controlled cross intersection, with priority given to Gertrude Street. Right turns out of the southern Napier Street approach are not permitted between 7:30am – 9:00am Monday to Friday.

The Napier Street / Victoria Parade intersection is a left out only 'Stop' controlled intersection, with priority given to Victoria Parade. Inbound movements into Napier Street are not permitted.

In the vicinity of the site, Napier Street operates with a posted speed limit of 40 kilometres per hour.

A view of Napier Street in the vicinity of the site is provided in Figure 2-12.

Figure 2-12 Cross Section of Napier Street in the Vicinity of the Site



2.6.5 Victoria Parade

Victoria Parade is a Declared Main Road which extends generally in an east-west direction from Hoddle Street to La Trobe Street. At both ends, Victoria Parade continues as Victoria Street. ACU is located on the north side of Victoria Parade, with access provided to an on-site car park.

In the vicinity of the site, Victoria Parade operates with three traffic lanes and a bus lane in each direction, separated by a wide central median which accommodates tram lines, tram stops and footpaths. Left and right turn deceleration lanes are provided at key intersections.

Along its length, parallel parking is intermittently permitted on both the north and south kerbs and as well as both kerbs of the central median, however in the vicinity of the site, parking is only permitted on the south kerb.

Victoria Parade operates with a posted speed limit of 60 kilometres per hour. A view of Victoria Parade in the vicinity of the site is provided in Figure 2-13.

Figure 2-13 View of Victoria Parade in the Vicinity of the Site

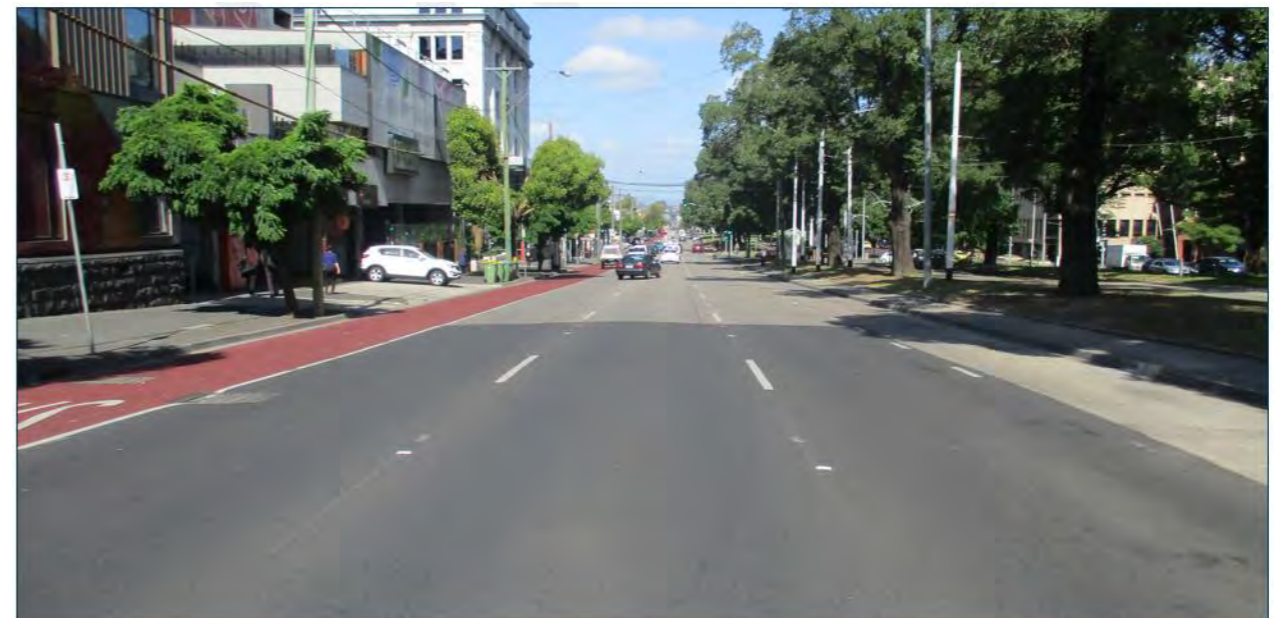

2.6.6 Little Victoria Street

Little Victoria Street is a right of way (ROW) which extends in an east-west direction from George Street to Little Napier Street. Little Victoria Street terminates at the eastern boundary of ACU, however does not provide vehicle access to the ACU.

In the vicinity of the site, Little Victoria Street operates as one way westbound only within a single traffic lane and provides access to Little Napier Street which services dwellings fronting Napier Street. Kerbside parking is not permitted.

A view of Little Victoria Street in the vicinity of the site is provided in Figure 2-14.

Figure 2-14 Cross Section of Little Victoria Street in the Vicinity of the Site



2.6.7 Little Napier Street

Little Napier Street is a right of way (ROW) which extends in a north-south direction from Gertrude Street to Little Victoria Street. Little Napier Street is aligned along part of ACU's eastern boundary, however does not provide vehicle access.

Little Napier Street operates as one way northbound only within a single traffic lane and services dwellings fronting Napier Street.

A view of Little Napier Street is provided in Figure 2-15.

Figure 2-15 Cross Section of Little Napier Street in the Vicinity of the Site



2.6.8 Graham Street

Graham Street is a local road which extends west from Young Street for approximately 45 metres before terminating. Graham Street extends to the boundary of ACU.

Graham Street operates as two way, however allows for a single direction of travel at any one time. Parallel parking is permitted on the northern kerb, as shown in Figure 2-16.

Figure 2-16 Cross Section of Graham Street in the Vicinity of the Site



2.6.9 Duke Street

Duke Street is a private road within ACU which extends west from Young Street for approximately 40 metres.

Duke Street operates as a shared zone, within a carriageway which allows for a single direction of travel at any one time. As required for shared zones, this section of Young Street operates with a speed limit of 10 kilometres per hour with a speed limit of 10 kilometres per hour.

No entry to Duke Street is permitted with the exception of authorised vehicles. The cross section of Duke Street in the vicinity of the site is provided in Figure 2-17.

Figure 2-17 Cross Section of Duke Street in the Vicinity of the Site

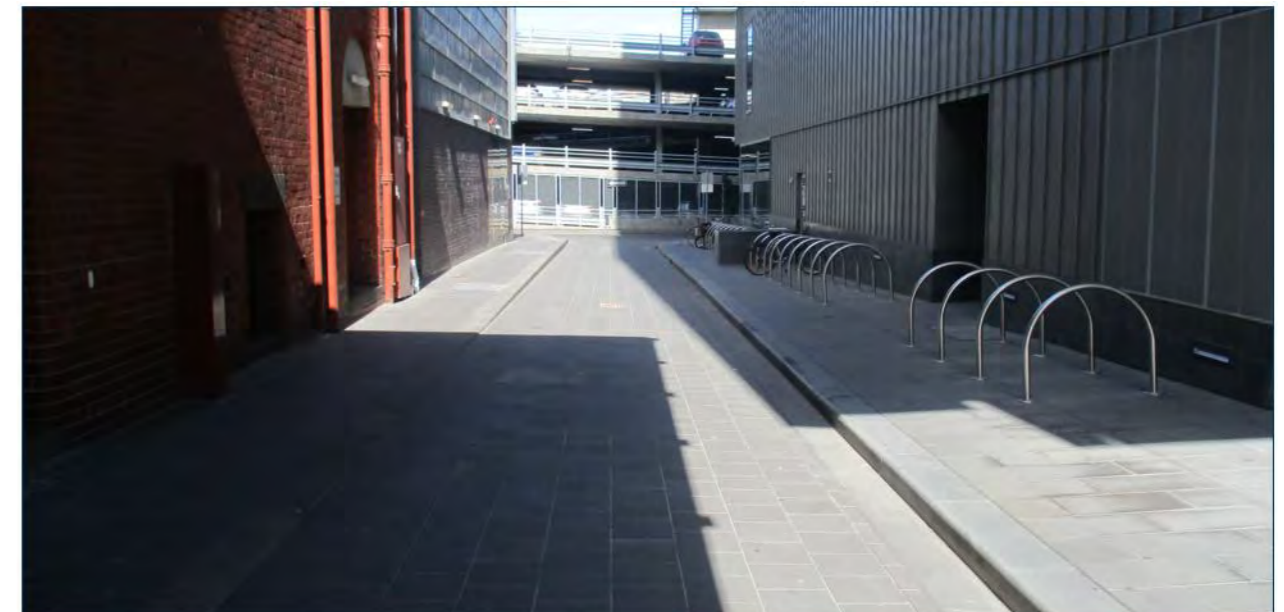

2.7 Road Network Safety

Casualty accident history for the roads and intersections adjoining the ACU, specifically, roads bound by Victoria Parade to the south, Gertrude Street to the north, Brunswick Street to the west and Napier Street to the east have been sourced from VicRoads CrashStats accident database.

A summary of the accidents in the area defined above for the last available five year period (1 July 2008 to 30 June 2013) are summarised in Figure 2-18.

Figure 2-18 Causality Accident History - 1 July 2008 to 30 June 2013



The CrashStats review indicates that a total of 33 casualty accidents have been reported within the nominated area within the five year period. Table 2-7 provides a broad summary of the accident categories.

Table 2-7 Accident Categories

Accident Type	Number
Involving Bicyclists	16
Involving Motor Cyclists	8
Involving Pedestrian	5
Involving Motorists Only	4
Total	33

2.8 Car Parking

The site is located in an area with constrained long term and short term on street parking opportunities with observations revealing that on street parking opportunities in the vicinity of the site are generally ticketed and or marked as permit zones with the limited number of long term (4 hours or greater) parking opportunities observed to be well utilised.

Notwithstanding the above, commercial off-street parking facilities are available and include the onsite parking spaces provided by the University, specifically, a 250 space deck car park accessible via Young Street, and a 50 space at grade car park accessible via Victoria Parade.

The location of these onsite parking areas are illustrated in Figure 2-19.

Figure 2-19 ACU Onsite Car Parking Spaces



3 State and Local Policies

3.1 State Policies

3.1.1 Plan Melbourne

Plan Melbourne outlines the vision for Melbourne's growth to the year 2050. The document was developed through extensive collaboration across government and a sustained dialogue with professional, industry and community stakeholders. In October 2013, Plan Melbourne was released for comment, with the final Plan Melbourne released in May 2014 following submissions.

Plan Melbourne specifies seven outcomes and objectives for Melbourne, summarised as follows:

- > **Delivering jobs and investment:** Create a city structure that drives productivity, supports investment through certainty and creates more jobs;
- > **Housing choice and affordability:** Provide a diversity of housing in defined locations that cater for different households and are close to jobs and services;
- > **A more connected Melbourne:** Provide an integrated transport system connecting people to jobs and services, and goods to market;
- > **Liveable communities and neighbourhoods:** Create healthy and active neighbourhoods and maintain Melbourne's identity as one of the world's most liveable cities;
- > **Environment and water:** Protect our natural assets and better plan our water, energy and waste management systems to create a sustainable city;
- > **A state of cities:** Maximise the growth potential of Victoria by developing a state of cities which delivers choice, opportunity and global competitiveness; and
- > **Implementation:** Delivering better governance: Achieve clear results and deliver outcomes through better governance, planning, regulation and funding mechanisms.

Plan Melbourne provides a number of directions to address the abovementioned outcomes and objectives. Those considered relevant to this report include:

- > **Direction 1.1:** Define a new city structure to deliver an integrated land use and transport strategy for Melbourne's changing economy;
- > **Direction 3.1:** Transform the transport system to support a more productive central city;
- > **Direction 3.2:** Improve access to job-rich areas across Melbourne and strengthen transport networks in existing suburbs; and
- > **Direction 3.4:** Improve local travel options to increase social and economic participation.

A discussion paper called Plan Melbourne Refresh was prepared in October 2015 to build upon the work and consultation undertaken in preparing Plan Melbourne, with Plan Melbourne 2016 to be released in the first half of 2016.

It is understood that Plan Melbourne 2016 will maintain the key priorities of Plan Melbourne 2014 but strengthen its focus on a number of areas.

3.1.2 Transport Integration Act

The Transport Integration Act 2010 creates a new framework for the provision of an integrated and sustainable transport system in Victoria. The Act provides a vision statement, reproduced below:

"The Parliament recognises the aspirations of Victorians for an integrated and sustainable transport system that contributes to an inclusive, prosperous and environmentally responsible State."

The Transport Integration Act recognises that the transport system should be considered as a single system and ensures that all transport agencies work together.

3.1.3 VicRoads' SmartRoads

SmartRoads is a policy implemented by VicRoads to manage competing interests for limited road space by giving priority use of the road to different transport modes at particular times of the day. Road Use Hierarchy Maps show the priority modes on each road for each Council area and form the foundation for the network operating plan.

The Road Use Hierarchy Map in the vicinity of the site is provided in Figure 3-1 and shows Victoria Parade as a tram priority, bus priority and traffic route, whilst Brunswick Street is shown as a tram priority and bicycle priority route as well as a pedestrian priority area.

Figure 3-1 SmartRoads Road Use Hierarchy Map

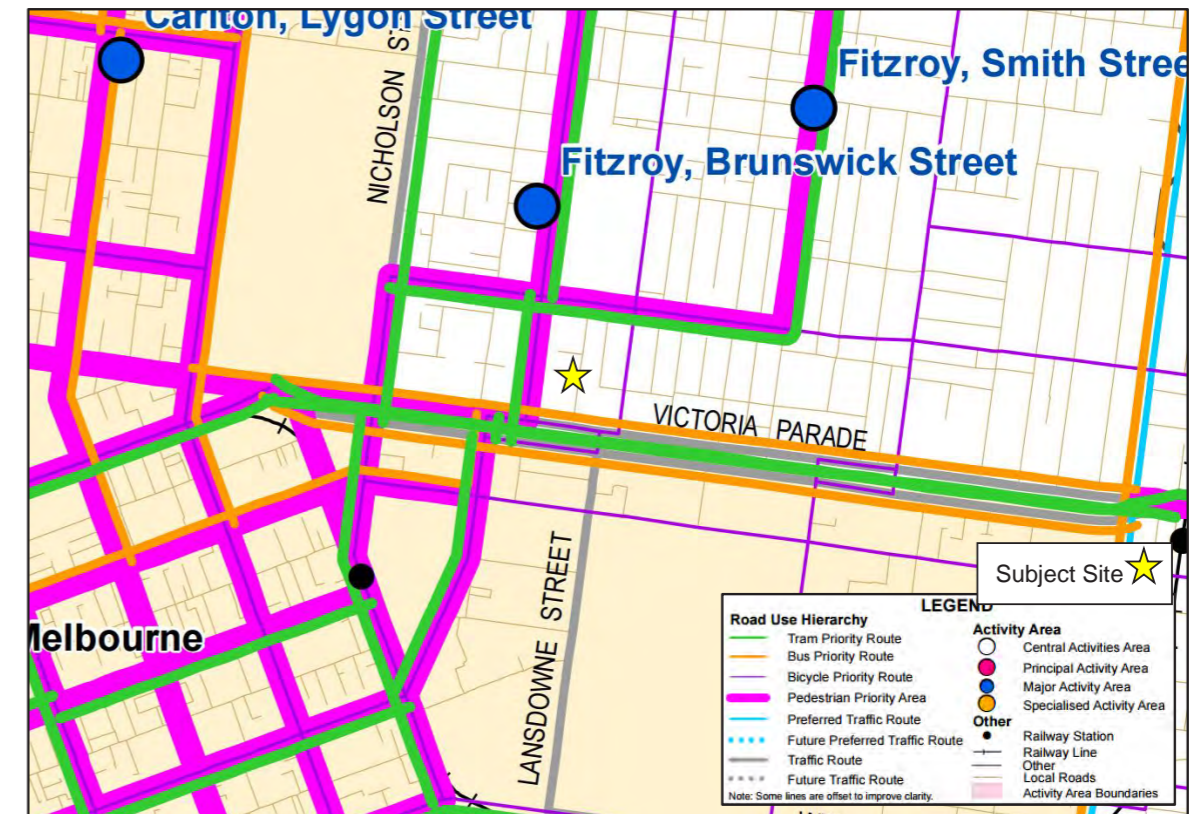

3.1.4 Victorian Cycling Action Plan 2013 & 2014

The Victorian Cycling Action Plan 2013 & 2014 was prepared for the Victorian Government and was released in December 2012. The document aims to grow and support cycling in Victoria by making it easier for more people to cycle and to make it safer for people who already ride as well as improving the cycling experience for all types of bike riders.

Six directions are identified within the Victorian Cycling Action Plan to achieve the above aims, reproduced as follows:

- > **Build evidence:** build a stronger evidence base for the Victorian Government to make more informed decisions;
- > **Enhance governance and streamline processes:** clarify accountability and improve co-ordination, planning and delivery;
- > **Reduce safety risks:** reduce conflicts and risks to make cycling safer;
- > **Encourage cycling:** help Victorians feel more confident about cycling and make cycling more attractive;
- > **Grow the cycling economy:** support opportunities to grow and diversify Victoria's economy through cycling; and
- > **Plan networks and prioritise investment:** plan urban cycling networks to improve connectivity and better target infrastructure investment for urban networks, regional trails and specialist cycle sport infrastructure.

3.1.5 Pedestrian Access Strategy

The Pedestrian Access Strategy was prepared in 2010 and aims to increase walking for transport in Victoria and notes that more people walking has the potential to help ease congestion, reduce greenhouse emissions, improve the health of Victorians and promote social connections.

The document lists five strategic directions for walking, reproduced as follows:

- > **Encourage people to walk by changing attitudes and behaviour:** This aims to make walking the top-of-mind choice for Victorians – especially for short trips – by making walking for transport a visible and valued part of daily life;
- > **Collaborate to improve provision for walking:** This aims to clarify the roles and responsibilities of both state and local governments in providing for walking. The Victorian Government will work with local governments to ensure they have the capacity and information they need to provide better pedestrian facilities;
- > **Create pedestrian-friendly built environments, streets and public spaces:** This aims to ensure built environments across Victoria facilitate easy and efficient pedestrian movements;
- > **Increase the safety of walking:** This will identify and address risks to pedestrians across the transport system and give pedestrians the skills to negotiate road environments; and
- > **Continue integrating walking with public transport:** This aims to ensure more Victorians walk in combination with public transport. Walkers need to find it easy to get to major public transport hubs across Victoria and easy walking access should be provided at public transport stops.

3.2 Local Policy

3.2.1 Clause 21.06 of the Yarra Planning Scheme

Clause 21.06 of the Yarra Planning Scheme details the City of Yarra's transport related objectives and strategies.

Clause 21.06 acknowledges that the City of Yarra needs to reduce car dependence by promoting walking, cycling and public transport use as viable and preferable alternatives. Clause 21.06 lists four objectives as follows:

- > **Objective 30:** To provide safe and convenient pedestrian and bicycle environments;
- > **Objective 31:** To facilitate public transport usage;
- > **Objective 32:** To reduce the reliance on the private motor car; and
- > **Objective 33:** To reduce the impact of traffic.

Of particular relevance to this report is Strategy 32.2 in response to objective 32, reproduced below:

- > **Strategy 32.2:** Require all new large developments to prepare and implement integrated transport plans to reduce the use of private cars and to encourage walking, cycling and public transport.

3.2.2 Strategic Transport Statement 2006 - City of Yarra

The Strategic Transport Statement is a document prepared by the City of Yarra in 2006 which addresses the access needs of Yarra's community whilst minimising the impact of cars on Yarra's community. The Strategic Transport Statement has a stated vision as follows:

"To create a city which is accessible to everyone irrespective of levels of personal mobility and where a fulfilling life can be had without the need for a car."

The Strategic Transport Statement lists seven key Strategic Transport Objectives to achieve the above vision as follows:

- > Create a city which is a great and safe place to walk and increase the numbers of those walking in Yarra.
- > Create the most bicycle friendly city in Australia and increase the numbers of those cycling in Yarra.
- > Advocate for increased performance of public transport across Melbourne and thereby reduce the number of car trips and through traffic by both Yarra and non-Yarra residents.
- > Ensure that any new road construction is not in conflict with encouraging more sustainable transport use.
- > Ensure Council's response to parking demand is based on Yarra's parking hierarchy and sustainable transport principles.

- > Work to limit freight movement to arterial roads and freeways within Yarra and work to reduce freight movement through Yarra.
- > Encourage Council staff to use more sustainable transport for their travel and increase the capacity of the Council as a whole to respond to and initiate positive actions to further strategic transport objectives 1 to 6.

3.2.3 City of Yarra Bicycle Strategy 2010 – 2015

The City of Yarra Bicycle Strategy 2010 – 2015 details the status on bicycle initiatives and lays out future plans for bicycle facilities, with an aim to establish cycling as a legitimate first choice of transport by people of all ages and cycling abilities.

The document lists 11 strategies to achieve the above, listed as follows:

- > **Strategy 1:** Better on-road bicycle network;
- > **Strategy 2:** Better local streets for cycling;
- > **Strategy 3:** Better off-road bicycle network;
- > **Strategy 4:** Better bicycle network maintenance;
- > **Strategy 5:** Better end of trip facilities – bicycle parking;
- > **Strategy 6:** Better bicycle network accountability;
- > **Strategy 7:** Better bicycle safety by reducing conflict;
- > **Strategy 8:** Better Council use of bicycles;
- > **Strategy 9:** Better recruitment and retention of cyclists;
- > **Strategy 10:** Better policies; and
- > **Strategy 11:** Better innovation and relationships.

3.2.4 Inner Melbourne Action Plan (IMAP)

The Inner Melbourne Action Plan (IMAP) was prepared by the Cities of Melbourne, Yarra, Port Phillip, and Stonnington in partnership with VicUrban and was adopted in December 2005. Maribyrnong City Council also became a member of the IMAP in 2013.

The IMAP lists a number of strategies to achieve its vision, including the following which are considered relevant to this report:

- > **Strategy 2:** Effectively link transport routes so that the Inner Melbourne Region is accessible throughout by walking, cycling and public transport;
- > **Strategy 3:** Minimise the growing impact of traffic congestion;
- > **Strategy 4:** Increase public transport use.

4 Development Proposal

4.1 Development Plan

The Development Plan has been developed to accommodate the ACU's projected growth in students, teaching staff and research from 2015 to 2025, whilst also allowing the consolidation of teaching and research activities onto the Campus.

Specifically it is anticipated that by 2020, ACU will increase their EFT student numbers to 10,700 and staff numbers to 850. A summary of existing and proposed student and staff numbers is provided in Table 4-1.

Table 4-1 Student and Staff Numbers

Existing	Proposed	Change
10,000 EFT Students	10,700 EFT Students	+700 EFT Students
800 Staff	850 Staff	+50 Staff

The key principle that will inform the Development Plan from a transport perspective is based on the City of Yarra's commitment to reduce car dependency by promoting walking, cycling and public transport use.

Specifically, the St Patrick's Campus Development Plan seeks to become a pedestrian oriented space that is safe for students and prioritises sustainable modes of transport by:

- > Improving access to public transport along Victoria Parade, Brunswick Street and Gertrude Street;
- > Ensuring pedestrian links from the Campus integrate and form part of the wider pedestrian network;

The above will be achieved through the creation of strong pedestrian linkages through the Campus and to adjacent uses, activities and transport networks. Notably, the facade treatment to Victoria Parade on the Mary Glowrey Building is to be removed and by so doing, substantially increasing the footpath width along Victoria Parade in the section between Young Street and Napier Street. This will be particularly beneficial at the interface of the Mary Glowrey Building and the existing bus stop.

4.2 Individual Projects

The individual projects within the Development Plan will include:

4.2.1 115 B Victoria Parade

This project will comprise of the subdivision of 115 Victoria Parade to create a new building site. Within this site, a multi storey building is contemplated, and will include the provision of basement level car parking for 270 spaces.

Vehicular access to this building is planned via Napier Street. Mitigation works will be required at the intersection of Victoria Parade and Napier Street to accommodate direct access via Victoria Parade.

4.2.2 28 - 42 Young Street (Existing Deck Car Park)

The existing 250 space deck car park is to be demolished and in its place a new building is proposed.

This new building will have no car parking spaces provided, instead, the development of this site will provide the opportunity to make substantial improvements to pedestrian access and connectivity between the campus buildings, and the adjacent campus uses and activities.

5 Transport Network Interventions

5.1 Pedestrian Network

The Development Plan contemplates improvements to pedestrian access throughout the Campus, with the aim of providing an attractive and safe pedestrian environment that will integrate with the surrounding local precinct.

The key initiatives in this regard will be the creation of strong pedestrian linkages through the Campus and to adjacent uses, activities and transport networks. Notably, the facade treatment to Victoria Parade on the Mary Glowrey Building is to be removed and by so doing, substantially increasing the footpath width along Victoria Parade in the section between Young Street and Napier Street. This will be particularly beneficial at the interface of the Mary Glowrey Building and the existing bus stop.

5.2 Bicycle Network

The mitigation works required at the intersection of Victoria Parade and Napier Street to accommodate vehicular access to the 115 B Victoria Parade project, provides the opportunity to improve cyclist amenity at this intersection.

The concept plan shown as Figure 5-1 illustrates the proposed mitigation works and improvements to cyclist amenity.

Figure 5-1 Victoria Parade / Napier Street – Concept Design

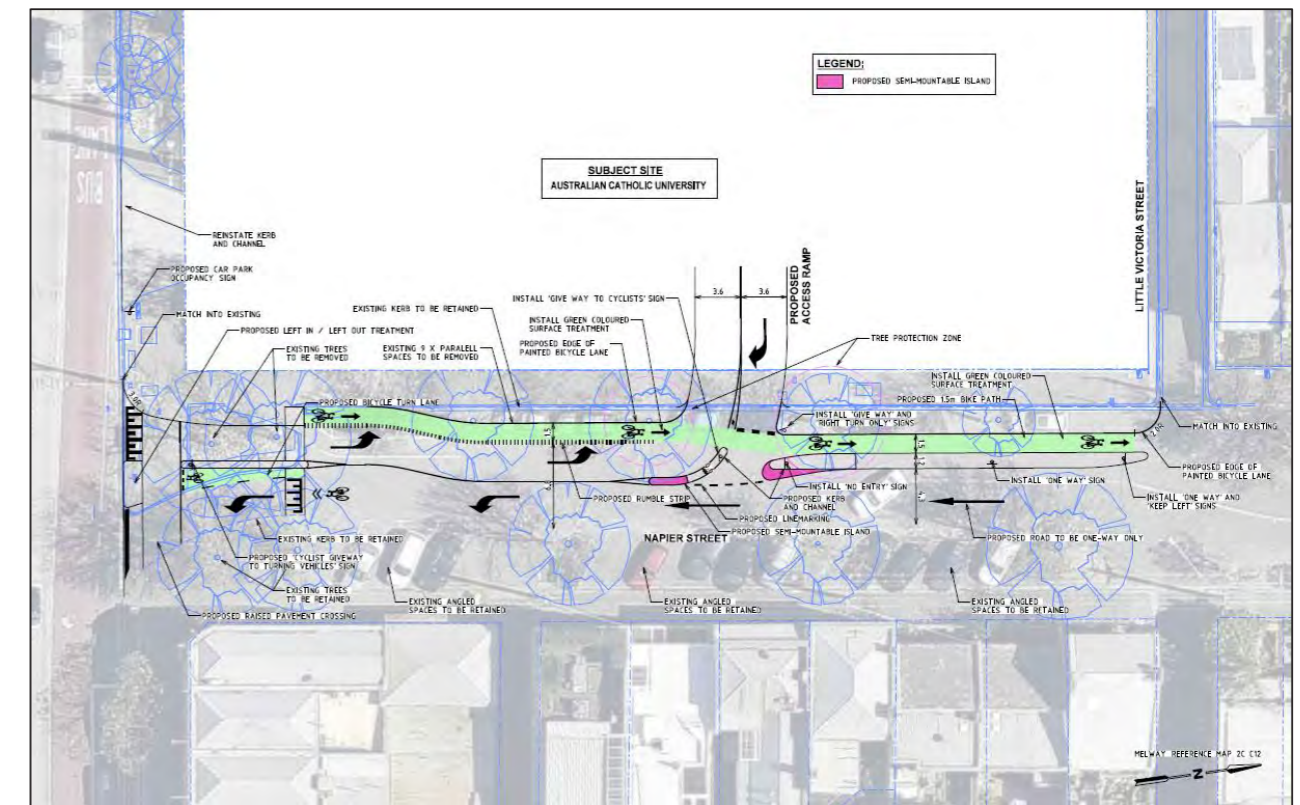

5.3 Local Area Traffic Management

The City of Yarra have over the years undertaken Local Area Traffic Management (LATM) studies to improve traffic conditions and road safety in local streets.

The studies looked at issues such as traffic speed and volume, pedestrian safety and comfort, and how to calm traffic so that neighbourhoods are more liveable. Notably, as part of these studies residents and businesses were surveyed about the traffic issues in the area and proposed treatments.

The ACU St Patrick's Campus is located within the bounds of Council's LATMS11 – Fitzroy area. An extract of LATMS11 – Fitzroy is provided as Figure 5-2

Figure 5-2 Extract of LATMS 11 – Fitzroy

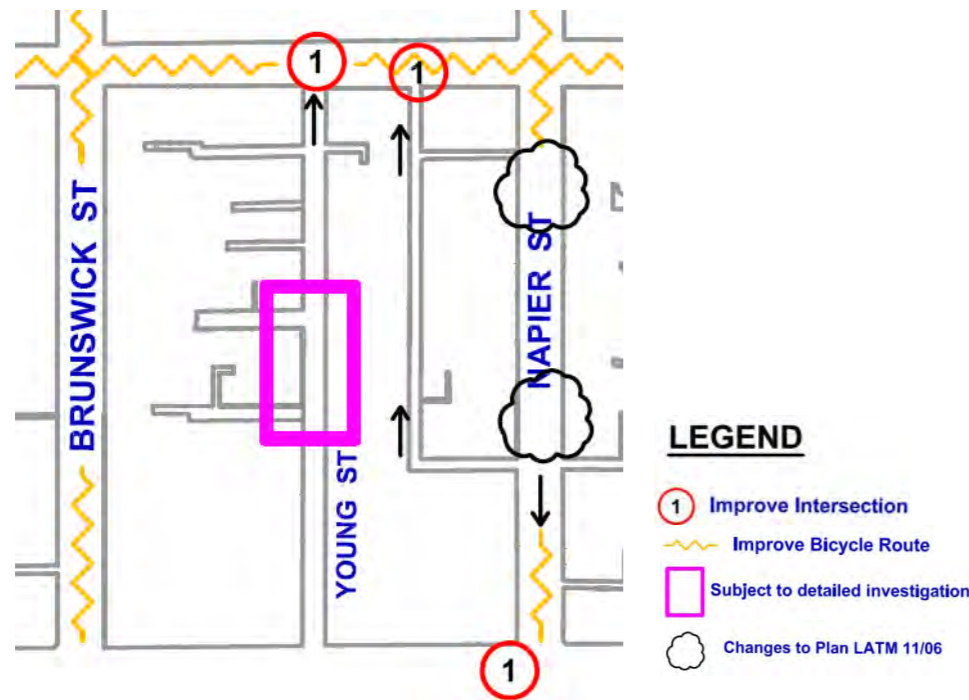

LATMS11 identifies the intersection of Victoria Parade and Napier Street as an intersection that requires improvement, furthermore, the section of Young Street between Little Victoria Street and Duke Street has also been identified as an area that is subject to detailed investigation.

Noting the foregoing, the proposed pedestrian and bicycle network interventions could be considered as options consistent with the aspirations of LATMS 11 – Fitzroy.

6 Statutory Considerations

6.1 Schedule 2 to the Development Plan Overlay

The statutory requirements applicable to the Development Plan are contained within Schedule 2 to the Development Plan Overlay.

The traffic specific requirements are reproduced below.

The development plan must show:

- > The number, location, dimensions, and layout of all car parks and access ways to and from them;
- > A management plan for the operation and maintenance of the car park areas;
- > The location and dimensions of all bicycle, vehicle and pedestrian ways;
- > A traffic management plan which must show any traffic management and traffic control works considered necessary in adjoining and nearby roads when the development is completed; and
- > The means of vehicular and pedestrian ingress to and egress from the land.

An assessment of the Development Plans against the above noted statutory requirements follows:

6.2 Design Response

6.2.1 Car Parking and Accessways

A total of 270 car spaces are proposed. These spaces are to be provided within basement levels on the 115 B Victoria Parade project.

Specific to the DPO Requirements:

- > Parking spaces are to be provided at a minimum 4.9m long and 2.6m wide;
- > Accessways within the car park are to be provided at a minimum 6.4m wide where they serve car parking spaces and a minimum 5.5m wide where they do not abut parking. The main accessway off Napier Street is provided at a width of 7.6m;
- > A minimum head height of 2.1 metres is proposed within the basement car park, increasing to 2.5m where provision is made for disabled spaces and Small Rigid Vehicles.

These dimensions are consistent with the requirements contained within Clause 52.06 of the City of Yarra Planning Scheme.

6.2.2 Bicycle Ways

An additional 80 bicycle spaces are to be provided as part of the Development Plan.

These bicycles are to be spread throughout the campus and designed to meet the dimension requirements set out by Bicycle Network and or AS2890.3:2015, and would comprise a mix as appropriate of the products as per the spec sheets provided as Appendix B.

6.2.3 Pedestrian Ways

These pedestrian linkages through the site are to be designed to meet and or exceed the relevant standards.

6.2.4 Means of Vehicular and Pedestrian Access

For the 115B Victoria Parade project, vehicular access is to be facilitated via Napier Street, as illustrated in the accompanying concept functional layout plan, Cardno drawing number CG150178-TR-DG-2505-3 provided as Appendix A.

Pedestrian access is to be provided via Victoria Parade, and Napier Street. The new building will also be accessible via existing pedestrian access points provided for the adjacent Mary Glowrey Building.

With regard to the 28 - 42 Young Street project, no car parking is proposed. Accordingly, no vehicular access is contemplated. Pedestrian access will be via Little Victoria Street and Young Street.

6.2.5 Traffic Management Plan

Victoria Parade / Napier Street

Vehicular access to the 115B Victoria Parade project will be via Napier Street. Ingress and egress will be restricted to the intersection of Victoria Parade and Napier Street.

This intersection will require mitigation works to allow access via Victoria Parade. The traffic management and traffic control works considered necessary to mitigate the impact of the development at this intersection are illustrated in Cardno drawing number CG150178-TR-DG-2502-3, provided as Appendix A.

Young Street

Tube count surveys undertaken on Young Street in October 2015, at a location north of the existing access to the deck car park indicates that on average Young Street carries about 550 vehicles per day northbound, with the car park contributing about 100 vehicles per day to this total figure. On weekends northbound traffic flows reduce to 250 vehicles per day.

On this basis, Young Street can be classified as an Access Place, noting:

- > An Access Place as defined by Clause 56.06 of the City of Yarra Planning Scheme, is a minor street providing local residential access with shared traffic, pedestrian and recreation use, but with pedestrian priority;
- > This road can accommodate an indicative maximum traffic volume of between 300 – 1000 vehicles over a 24-hour period, within a 5.5m wide carriageway with parking on one side of the carriageway.

The proposed demolition of the existing deck car park will remove traffic currently generated by the car park, thus reducing daily traffic flows along this road to the benefit of pedestrian movements via the reduction in the potential for vehicle and pedestrian conflicts.

6.2.6 Car Park Management Plan

The following conditions detail the operation and management of the car parking spaces proposed within the 115B Victoria Parade project.

- > The parking area will be secured by boom gates, activated by card readers and ticket machine on entry and departure during the facility's operating hours, anticipated to be between 7:00am – 10:30pm Weekdays and 8:00am – 10:30pm weekends consistent with current operational practises for the existing car park. During afterhours the car park will be secured by roller doors.
- > To alert casual parkers entering the car park and ensure ease of use, clearly visible advisory signs will be posted on the car park entry and also within the car park. Additionally, to avoid conflict between long term (staff) and short term (students) users, spaces will be designated to individual staff members once they are determined, with signage posted at the end of each bay.
- > Operation of the public car park will be limited to the hours listed above, with its fee structure expected to be based on an hourly charge rates in-line with other commercial car park facilities in the vicinity of the site. The actual charge rates will however be determined once an operator is appointed. The car park is to be operated by ticket collection on entry, and then payment at a pay station likely to be located adjacent to the lifts.
- > Dynamic signage on Victoria Parade will be provided to indicate if the car park is full, which will reduce the number of vehicles turning into Napier Street during high occupancy periods. Notwithstanding, U-turn movements can be undertaken within the ROW located on the east side of Napier Street midblock between the site access and Victoria Parade.

6.3 Car Parking - Clause 52.06

6.3.1 Car Parking Requirement

Table 1 to Clause 52.06 of the City of Yarra Planning Scheme sets out the car parking provision rates that apply to the Development Plan.

Specifically, Clause 52.06 requires that parking for the University is provided at a minimum rate of:

- > 0.4 spaces to each student that is part of the maximum number of students on site at any one time.

The student population on the campus is projected to increase by 700 students, in the period between 2015 – 2020.

Application of this rate to the proposed increase in students reveals a statutory requirement to provide a minimum 280 spaces.

6.3.2 Car Parking Provision

A total of 270 spaces are proposed as part of the 115B Victoria Parade Project, whilst the 28 - 42 Young Street project contemplates the demolition of the 250 space deck car park, with no additional parking provided on this site.

The building at 115B Victoria Parade will also be built on the existing at-grade car park site currently providing 50 spaces.

Accordingly the Development Plan results in a net decrease of 30 spaces, against a statutory requirements of 280 spaces.

This provision is considerably lower than the statutory requirements, and as such is in line with the sustainable transport objectives set out in local and state level policies.

6.4 Bicycle Parking – Clause 52.34

6.4.1 Bicycle Parking Requirement

Table 1 to Clause 52.34 of the City of Yarra Planning Scheme sets out the bicycle parking provision rates that apply to the Development Plan.

Specifically, Clause 52.34 requires that bicycle parking for the University is provided at a minimum rate of:

- > 1 space to each 20 employees; plus
- > 1 space to each 20 full time students.

The student population on the campus is projected to increase by 700 students, with a corresponding increase in staff numbers of 50 in the period between 2015 – 2020.

Application of these rates to the proposed increase in staff and students reveals a statutory requirement to provide a minimum 38 bicycle spaces comprising, 3 staff spaces and 35 student spaces.

6.4.2 Bicycle Parking Provision

It is intended to provide an additional 80 bicycle spaces. These spaces will be provided across the campus, not contained within the DPO area.

This provision is double the statutory requirements, and as such is in line with the sustainable transport objectives set out in local and state level policies.

7 Traffic Impact

7.1 Projected Traffic Volumes

The existing ACU deck car park with 250 spaces used by both staff and students provides a suitable reference to inform consideration about projected traffic volumes at the proposed 270 space car park at the 115B Victoria Parade project.

The existing car park was surveyed on

- Wednesday 21st May 2014 between 7am to 7pm; and
- Wednesday 7th October 2015 between 7am to 7pm

Figure 7-1 and Figure 7-2 provide a summary of the traffic profile at the ACU car park access points.

Figure 7-1 ACU Car Parking Access Profile – Wednesday 21st May 2014

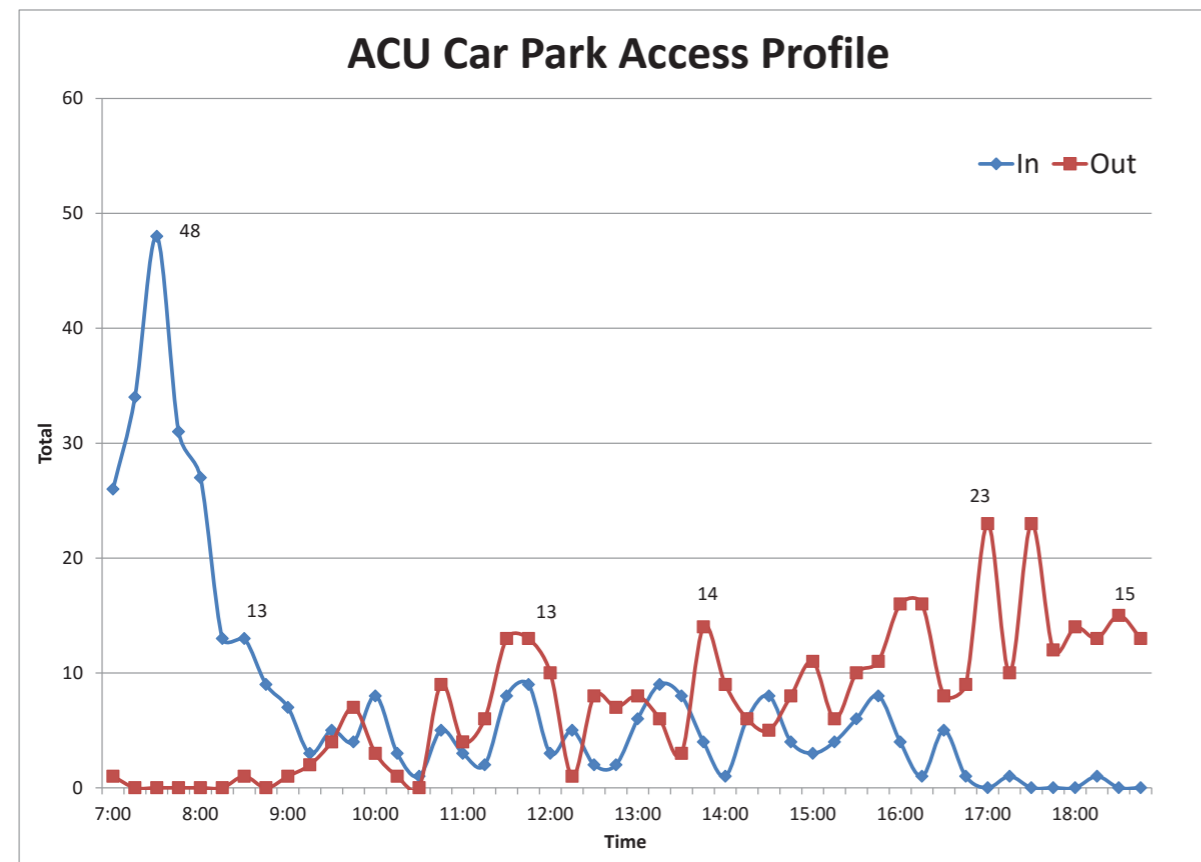

The key findings were as follows:

- > There were a total of 355 inbound movements and 360 outbound movements; and
- > The AM and PM peak hour was found to occur between 7:15am - 8:15am and 5:00pm-6:00pm respectively, when a total of 140 and 68 vehicle movements were recorded at the site access points respectively;

The above equates to about 60 % of the car parking spaces filling during the AM peak period, and about 30% of the spaces emptying during the PM peak. Traffic flows during the peak periods was observed as being heavily biased towards the peak direction.

Figure 7-2 ACU Car Parking Access Profile – Wednesday 7th October 2015

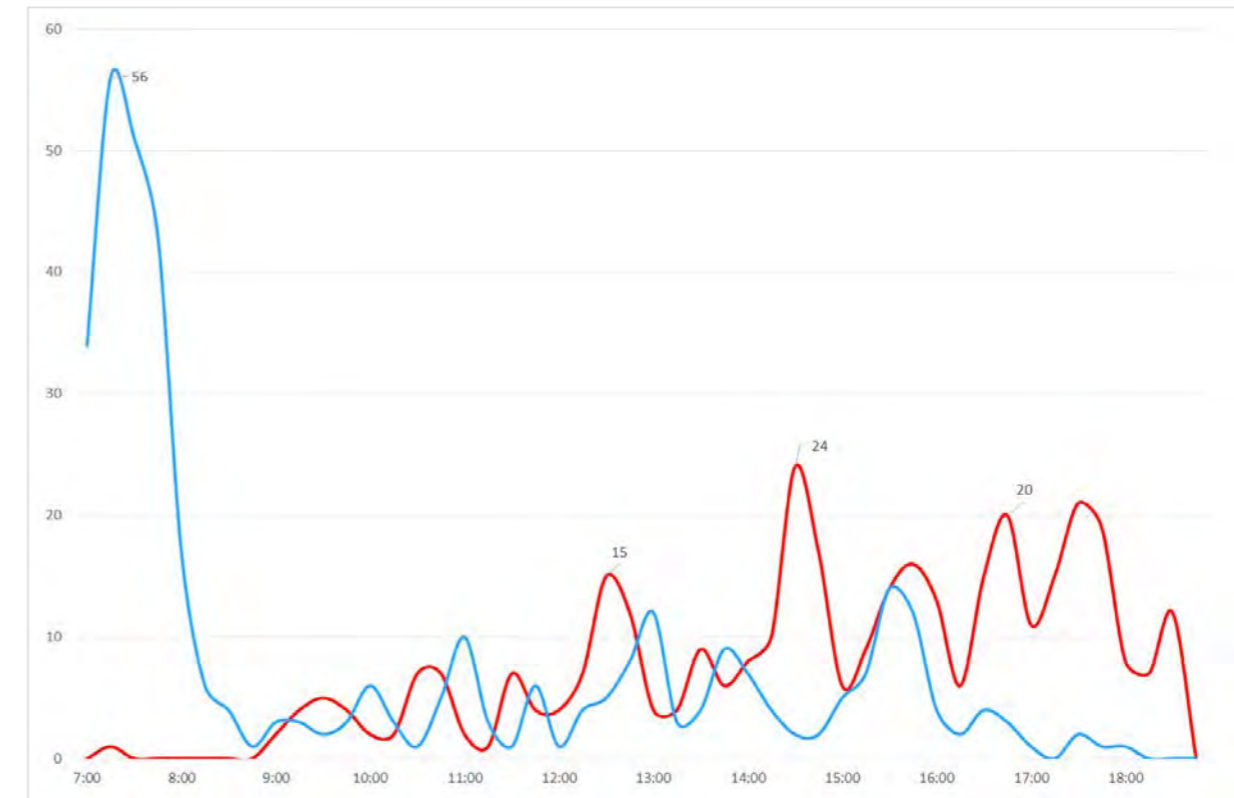

The key findings were as follows:

- > There were a total of 375 inbound movements and 360 outbound movements; and
- > The AM and PM peak hour was found to occur between 7:00am - 8:00am and 3:15pm-4:15pm respectively, when a total of 185 and 45 vehicle movements were recorded at the site access points respectively.

The above equates to about 75 % of the car parking spaces filling during the AM peak period, and about 20% of the spaces emptying during the PM peak. Traffic flows during the peak periods was observed as being heavily biased towards the peak direction.

Conservatively adopting a rate of 75 % of the car spaces filling during the AM peak and 30% emptying during the PM peak, the proposed 270 space car park would be projected to generate:

- > 203 vehicle movements during the AM peak period; and
- > 81 vehicle movements during the PM peak period.

For the purpose of this assessment, traffic flows will be biased 95% in the peak direction and 5% in the non-peak direction.

7.2 Traffic Distribution

Traffic to and from the proposed car park will be restricted to the Victoria Parade / Napier Street intersection. This intersection will operate as a left in / left out, with all traffic arriving from the west and departing towards the east. Figure 7-3 illustrates the projected additional traffic flows at this intersection.

Figure 7-3 Projected Additional Traffic Flows – Victoria Parade / Napier Street

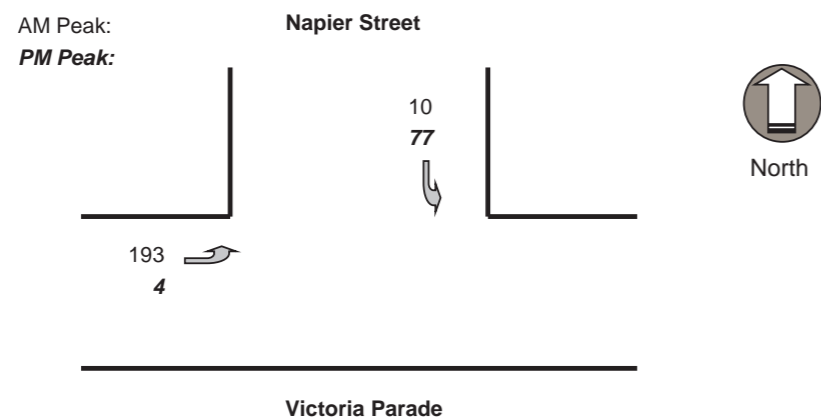

Based on historic traffic data collected on Napier Street in 2010, Napier Street at a location north of Little Victoria Street carries on average about 700 southbound vehicles per day, inclusive of about 100 vehicle movements during the AM peak period and 50 vehicle movements during the PM peak period.

7.3 Post Development Traffic Flows

SCATS data sourced from VicRoads for Thursday 8th October 2015 at the intersection of Victoria Parade / Lansdowne Street, show that during the AM peak periods occurs between 11:00am – 12:00pm, when 1,400 vehicles are recorded past Napier Street. The PM peak period occurs between 5:00pm – 6:00pm, with 2,082 vehicles recorded past this intersection.

Noting that Napier Street is located a short distance downstream of the signalised intersection of Victoria Parade / Lansdowne Street, platooning of traffic during the peak periods has been observed which assists motorists seeking to depart from Napier Street.

Allowing for the estimated existing traffic flows on Napier Street and the recorded traffic flows along Victoria Parade, the anticipated post development traffic flows are illustrated as Figure 7-4.

Figure 7-4 Anticipated Post Development Traffic Flows – Victoria Parade / Napier Street

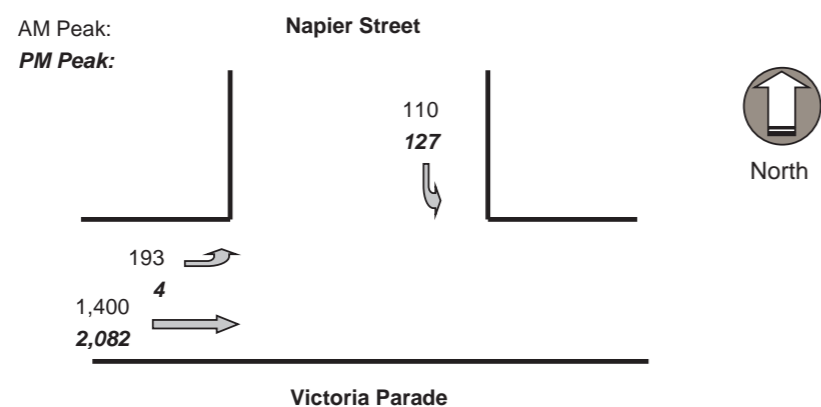

7.4 Intersection Analysis

The operation of the Victoria Parade / Napier Street intersection was analysed using SIDRA Intersection. This computer package, originally developed by the Australian Road Research Board, provides information about the capacity of an intersection in terms of a range of parameters, as described below:

Degree of Saturation (D.O.S.) is the ratio of the volume of traffic observed making a particular movement compared to the maximum capacity for that movement. Various values of degree of saturation and their rating are shown in Table 7-1.

Table 7-1 Rating of Degrees of Saturation

D.O.S.	Rating
Up to 0.6	Excellent
0.6 to 0.7	Very Good
0.7 to 0.8	Good
0.8 to 0.9	Fair
0.9 to 1.0	Poor
Above 1.0	Very Poor

It is considered acceptable for some critical movements in an intersection to operate in the range of 0.9 to 1.0 during the high peak periods, reflecting actual conditions in a significant proportion of suburban signalised intersections.

The **95th Percentile (95thile) Queue** represents the maximum queue length, in metres, that can be expected in 95% of observed queue lengths in the peak hour; and

Average Delay is the delay time, in seconds, which can be expected over all vehicles making a particular movement in the peak hour.

The results of the SIDRA Intersection analysis are summarised in Table 7-2.

Table 7-2 SIDRA Intersection Analysis Summary

	Approach	Degree of Saturation	95 th ile Queue	Average Delay
AM Peak	Napier Street (North)	0.174	5 metres	12 seconds
	Victoria Parade (West)	0.252	0 metres	1 second
PM Peak	Napier Street (North)	0.298	8 metres	16 seconds
	Victoria Parade (West)	0.375	0 metres	0 seconds

Based on the foregoing the intersection of Victoria Parade and Napier Street is expected to operate under excellent conditions, with motorists experiencing minimal queues and delays.

7.4.2 Operation of Site Access

An assessment of the operation of the site access has been undertaken to determine likely queues at the control point, especially during the AM peak period.

The analysis shows that during the AM peak period when 193 ingress vehicle movements are projected, 95th %ile queues of 4 vehicles are anticipated.

The boom gates are to be located at the bottom of the ramp, and will therefore afford motorists a queuing distance of about 24 metres, measured from the title boundary.

This setback can accommodate about 4 vehicles and as such queues on to Napier Street are not anticipated.

The design and location of the proposed car park access is therefore not expected to result in conditions that obstruct traffic flows along Napier Street or Victoria Parade.

8 Green Travel Initiatives

8.1 Preamble

Green Travel initiatives are aimed at encouraging people to choose sustainable travel alternatives such as cycling, walking or public transport, over private car usage. It is the view of the State Government that tertiary institutions are typically considered positive environments for the application of travel behaviour change programs as many students and staff already support sustainable transport for environmental, financial and social reasons.

Accordingly, and in consultation with Council, the University could develop a Green Travel Plan that would seek to encourage staff and students to choose sustainable travel alternatives such as public transport, cycling and walking.

8.2 Objective

As a guide, the objective of this travel plan would be to increase the proportion of alternative modes of transport users to 90% within 5 years.

The co-ordination and implementation of the Green Travel Plan would be the responsibility of the University in consultation with Council to:

- > Increase awareness of sustainable transport options to new and ongoing staff and students at the Campus;
- > Encourage behavioural change in both new and on-going staff and students from single-occupant motor vehicle use, to alternative methods of transport i.e. trams, buses and bicycle/walking paths;
- > Implement travel/behaviour change strategies and use pre/post surveys to monitor changes in attitudes and reported behaviour;
- > Identify infrastructure changes / improvements to alternative travel mode infrastructure within the locality that will facilitate take-up of sustainable transport behaviours by the University community.

8.3 Action Plan (Guide Only)

Various strategies can be adopted to encourage the use of non-private motor vehicles, as described in action plans below.

8.3.1 General Actions

Action	Timeline	By whom	Approx cost
Strategic Marketing			
Promotion of Green travel initiatives during orientation and enrolment & re enrolment periods.	Ongoing - from time of occupation	University	
Toilet talk – a series of posters behind toilet doors where people can read them in private!			
An events calendar: 3-4 events per year. Best in conjunction with state wide events such as Ride to Work Day, World Environment Day, National Walk to Work Day. Plan for lunch, morning teas or breakfasts, guest speakers, demonstrations etc.			
Display boards in prominent locations to showcase green travel initiatives.			

8.3.2 Walking

Action	Timeline	By whom	Approx cost
Produce a map showing safe walking routes to and from the University with indicative walking times, not distances, to local facilities, such as shops and bus stops (people often have an unrealistic idea of how long it takes to walk).	On Occupation	University	
Provide umbrellas in staff rooms to encourage staff members to consider walking during adverse weather periods.			
Create a sustainable travel tab on the University web page with links to appropriate external and internal websites.			
Negotiate with council for improvements to footpaths in the vicinity of the site.	Ongoing	University & Council	

8.3.3 Cycling

Action	Timeline	By whom	Approx cost
Establish a University "Bicycle Users Group" (BUG). BUGs are formed by people who want to work together to improve facilities for cyclists and encourage cycling.	On Occupation	University	
Participate in annual events such as 'Ride to Work Day.'	Ongoing		
Provide sufficient bicycle parking and end of trip facilities (lockers / showers) to meet staff and student needs, which is easily accessible and secure.	On Occupation		
Ensure bicycle parking is clearly visible or provide signage to direct people to cycle bays.			
Produce a map showing quiet cycle routes to the University.			
Create a sustainable travel tab on the University web page with links to appropriate external and internal websites			
Improvements to Bicycle Infrastructure as identified in Yarra City Council's Draft Bicycle Strategy, such as modifications to the adjacent traffic signals along Victoria Parade to facilitate connections to the bicycle routes in the City of Melbourne.		Council	

8.3.4 Public Transport

Action	Timeline	By whom	Approx cost
Develop a map showing public transport routes to the University.	On occupation	University	
Put up a noticeboard with leaflets and maps showing the main public transport routes to and from the University.	On occupation		
Create a sustainable travel tab on the University web page with links to appropriate external and internal websites.	On occupation		
Encourage public transport use for business travel. This could be done by ensuring shared tickets are available at the University for work travel during the day.	Ongoing		
Participate in the Public Transport Victoria (PTV), 'Commuter Club' scheme, which allows employers to purchase discounted yearly MYKI cards on behalf of their employees.			

8.3.5 Car Parking / Car Pooling

Action	Timeline	By whom	Approx cost
Set up a car pooling database.	Within 12 Months of Occupation	University	
Allocate priority parking spaces for car poolers.			
Provide sustainable transport allowances for staff who surrender car parking permits.			
Review pricing policy for existing ACU off street car park.			

The above draft action plans are an outline of the actions and incentives that could be undertaken / provided and is subject to agreement between the University and Council.

8.4 Monitoring and Review

In order to monitor the success of the aforementioned Green Travel Initiatives a 3 stage monitoring system could be implemented by the University.

Elected University representatives, both staff and students would be assigned as Travel Co-ordinators of the Travel Plan. The co-ordinators would be responsible for:

- > Organising the monitoring of the performance of the Travel Plan against the targets that have been agreed.
- > Reviewing the occupancy / use (and abuse) of the facilities that are provided on site, for example, cycle racks, motorcycle and motorcar parking spaces, clothes lockers, and travel information etc.

- > Reviewing the operational success or failure of the plan and produce a review report highlighting successful initiatives and also areas that require improvement. This review report would be issued to Council on an annual basis and would form the platform of an updated Travel Plan, with sign off/ input from Council sought on a regular basis, the duration of which would be determined by the relevant stake holders.

The suggested 3 stage monitoring program is outlined below:

Stage 1

- > Stage 1, would involve a questionnaire survey of students and staff during the enrolment process. The survey will be useful to collect information on the travel characteristics of the staff and students and assist in gauging interest in the various Green Travel initiatives and to seek ideas for other Green Travel initiatives.

Stage 2

- > Stage 2, would involve a questionnaire and feedback form to be filled out by Students and Staff 3 months after implementation, in order to determine what Green Travel initiatives are working and which are not. A pro forma for the Stage 2 questionnaire is shown attached as Annex 1.

Stage 3

- > Stage 3, would be the monitoring component of the plan which would be undertaken 6 months after occupation. This questionnaire would test the success rate of the various initiatives and help rework programs to suit the needs of staff and students. A pro forma for the Stage 3 questionnaire is shown attached as Appendix 1.

It is expected that the above stages would form the basis of a continuous monitoring program to gauge the effectiveness of the travel plan.

9 Conclusions

- > The Development Plan has been developed to accommodate the ACU's projected growth in students, teaching staff and research from 2015 to 2025, whilst also allowing the consolidation of teaching and research activities onto the Campus.

Specifically it is anticipated that by 2020, ACU will increase their EFT student numbers to 10,700 and staff numbers to 850

- > The individual projects within the Development Plan will include:

115 B Victoria Parade

This project will comprise of the subdivision of 115 Victoria Parade to create a new building site. Within this site, a multi storey building is contemplated, and will include the provision of basement level car parking for 270 spaces.

Vehicular access to this building is planned via Napier Street. Mitigation works will be required at the intersection of Victoria Parade and Napier Street to accommodate two-way vehicle flow within the southern portion of Napier Street.

In principle approval has been secured from VicRoads and Council to the suite of mitigation works proposed.

28 - 42 Young Street (Existing Deck Car Park)

The existing 250 space deck car park is to be demolished and in its place a new building is proposed.

This new building will have no car parking spaces provided, instead, the development of this site will provide the opportunity to make improvements to pedestrian access and connectivity between the campus buildings, and the adjacent campus uses and activities.

- > The key principle that will inform the Development Plan from a transport perspective is based on the City of Yarra's commitment to reduce car dependency by promoting walking, cycling and public transport use.

Specifically, the St Patrick's Campus Development Plan seeks to become a pedestrian oriented space that is safe for students and prioritises sustainable modes of transport by:

- Improving access to public transport along Victoria Parade, Brunswick Street and Gertrude Street;
- Ensuring pedestrian links from the Campus integrate and form part of the wider pedestrian network;

The above will be achieved through the creation of strong pedestrian linkages through the Campus and to adjacent uses, activities and transport networks. Notably, the facade treatment to Victoria Parade on the Mary Glowrey Building is to be removed and by so doing, substantially increasing the footpath width along Victoria Parade in the section between Young Street and Napier Street. This will be particularly beneficial at the interface of the Mary Glowrey Building and the existing bus stop.

- > A total of 270 spaces are proposed as part of the 115B Victoria Parade Project and results in the loss of 50 existing at-grade spaces, whilst the 28 - 42 Young Street project contemplates the demolition of the 250 space deck car park, with no additional parking provided on this site. Accordingly the Development Plan seeks to provide a net decrease of 30 spaces, against a statutory requirements of 280 spaces.

- > The proposed 115B Victoria Parade Car Park will be operated and managed as follows:

- The parking area will be secured by boom gates, activated by card readers and ticket machine on entry and departure during the facility's operating hours, anticipated to be between 7:00am – 10:30pm Weekdays and 8:00am – 10:30pm weekends consistent with current operational practises for the existing car park. During afterhours the car park will be secured by roller doors.
- To alert casual parkers entering the car park and ensure ease of use, clearly visible advisory signs will be posted on the car park entry and also within the car park. Additionally to avoid conflict between long term (staff) and short term (students) users, spaces will be designated to individual staff members once they are determined, with signage posted at the end of each bay.
- Operation of the public car park will be limited to the hours listed above, with its fee structure expected to be based on an hourly charge rate in-line with other commercial car park facilities in the vicinity of the site. The actual charge rates will however be determined once an operator is appointed. The car park is to be operated by ticket collection on entry, and then payment at a pay station likely to be located adjacent to the lifts.

- Dynamic signage on Victoria Parade will indicate if the car park is full, which will reduce the number of vehicles turning into Napier Street. Notwithstanding, U-turn movements can be undertaken within the ROW located on the east side of Napier Street midblock between the site access and Victoria Parade.
- > The proposal triggers a statutory requirement to provide 38 bicycle spaces. A total of 80 bicycle parking spaces are proposed. This provision is double the statutory requirements, and as such is in line with the sustainable transport objectives set out in local and state level policies.
- > An assessment of the post development intersection operating conditions shows that with the mitigation works proposed, the Victoria Parade and Napier Street intersection will to operate under excellent conditions, with motorists experiencing limited queues and delays.
 Additionally, an assessment of the operation of the site access has revealed 95th %ile queues of 4 vehicles are anticipated during the critical AM peak period. The design of the car park access and proposed location of the control points is such that motorists will be afforded a queuing distance of about 24 metres, measured from the title boundary.
 This setback can accommodate about 4 vehicles and as such queues on to Napier Street are not anticipated. The design and location of the proposed car park access is therefore not expected to result in conditions that obstruct traffic flows along Napier Street or Victoria Parade.
- > ACU will also actively pursue Green Travel initiatives aimed at encouraging people to choose sustainable travel alternatives such as cycling, walking or public transport, over private car usage.

Australian Catholic University, St. Patricks Campus, Fitzroy

APPENDIX

A

CONCEPT FUNCTIONAL LAYOUT PLANS

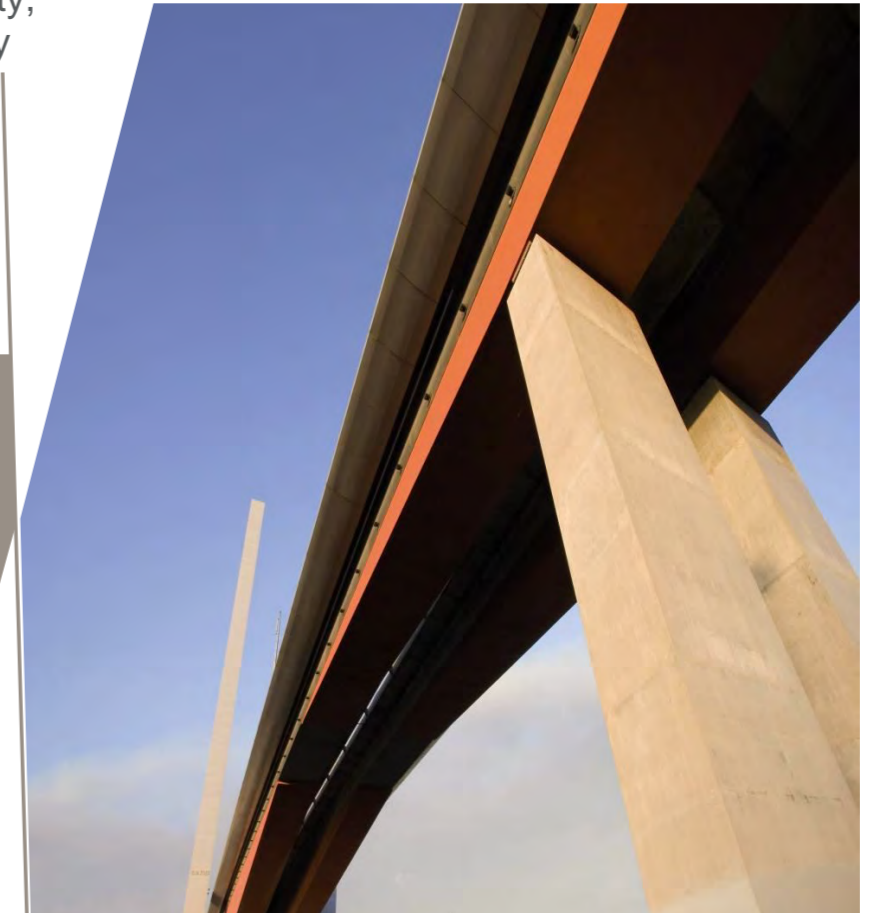

BY: chris.sanstoupet

DATE PLOTTED: 26/10/2016 2:10:53 PM

CAD File: \\AUJELCF001\cardno.comp\GSR_Data\DRATRAFF2015\CG150178\Drawings\CG150178-TR-DG-2502.dgn

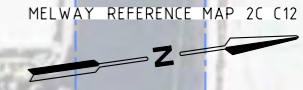
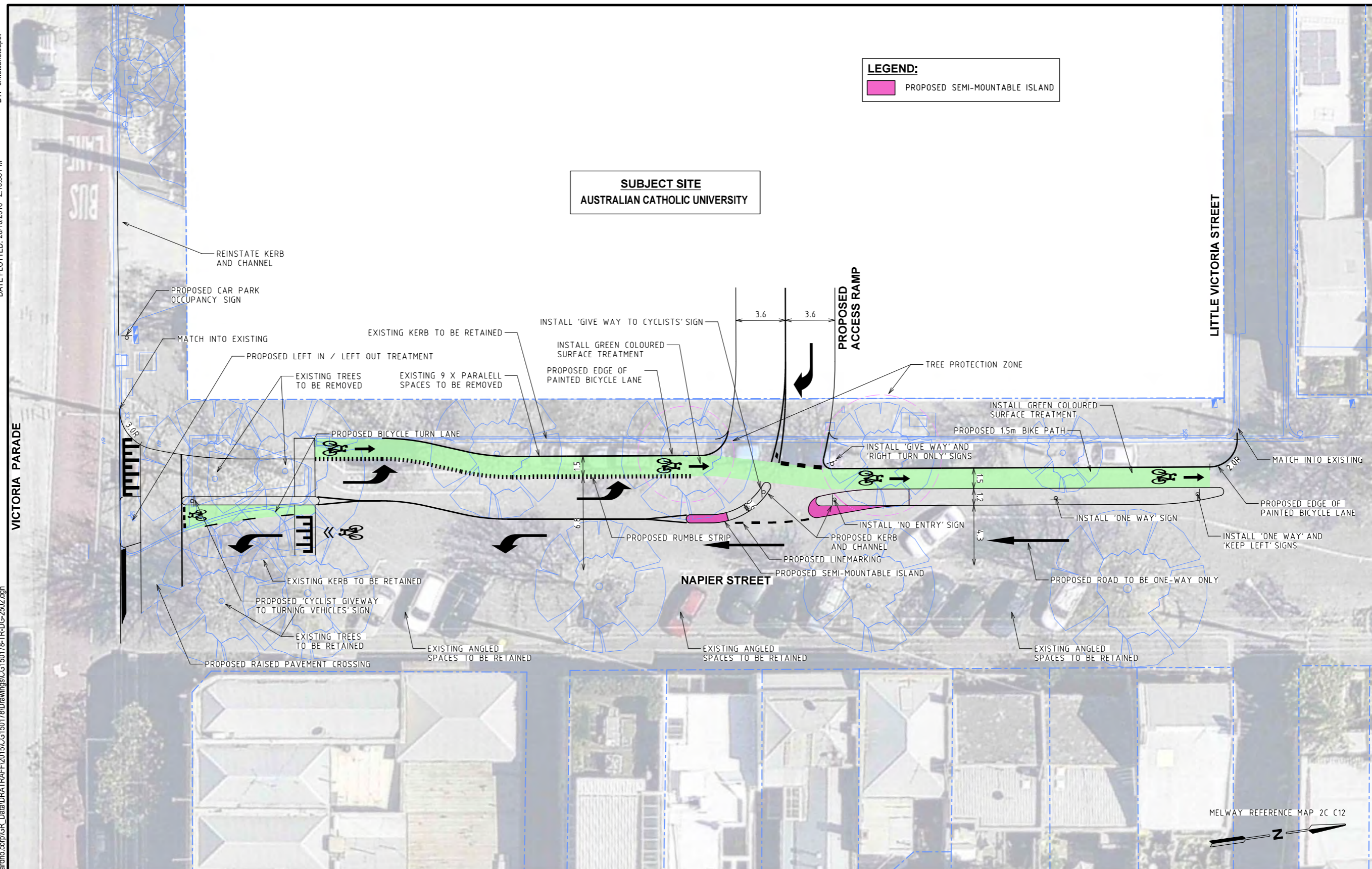

Rev	Date	Description	Drawn	Appr.
4	05.10.2016	COUNCIL COMMENTS	CS	SM
3	11.10.2016	COUNCIL COMMENTS	TR	SM
2	07.10.2016	CLIENT COMMENTS	EG	SM
1	27.09.2016	ISSUED FOR INFORMATION	CS	JPM

© Cardno Limited All Rights Reserved.
 This document is produced by Cardno Limited solely for the benefit of and use by the client in accordance with the terms of the retainer. Cardno Limited does not and shall not assume any responsibility or liability whatsoever to any third party arising out of any use or reliance by third party on the content of this document.

WARNING
 BEWARE OF UNDERGROUND SERVICES
 THE LOCATIONS OF UNDERGROUND SERVICES SHOWN ARE APPROXIMATE ONLY AND THEIR EXACT POSITION SHOULD BE PROVEN ON SITE.

1. BASE INFORMATION SUPPLIED BY BOSCO JONSON PTY LTD. REF No. 29460 AND HEADMAP AERIAL PHOTOGRAPHY. (BASE INFORMATION IS PARTIALLY INDICATIVE. SUBJECT TO FULL FEATURE SURVEY)
2. ALL DIMENSIONS TO FACE OF KERB AND CHANNEL U.N.O
3. DECLARED ROAD - VICTORIA PARADE (SPEED ZONE 60KM/H) LOCAL ROAD - NAPIER STREET (SPEED ZONE 50KM/H)
4. LINE MARK IN ACCORDANCE WITH VICROADS TEM VOLUME 2 AND REMOVE ALL REDUNDANT LINEMARKING.

ABN: 47 106 610 913
 501 Swanston Street, Melbourne, VIC Australia 3000
 Phone (+61 3) 8415 7777 Fax (+61 3) 8415 7788
 Email: victoria@cardno.com.au Web: www.cardno.com.au/victoria

Drawn	C.SANSTOUPET
Designed	C.SANSTOUPET
Checked	JP.MAINA
Authorised	JP.MAINA

Client	AUSTRALIAN CATHOLIC UNIVERSITY
Project	AUSTRALIAN CATHOLIC UNIVERSITY NAPIER STREET, FITZROY CITY OF YARRA
Title	SIGNAGE AND LINEMARKING PLAN FUNCTIONAL LAYOUT PLAN OPTION 02

Status	PRELIMINARY		
	NOT TO BE USED FOR CONSTRUCTION PURPOSES		
Date	11.10.2016	Scale	1:250
Size	A3	Revision	4
Drawing Number	CG150178-TR-DG-2502		

BY: User:regan.cook

DATE PLOTTED: 27/10/2016 11:41:11 AM

CAD File: \\MELCFS01\cardno.com\GPR_Data\DRATRAFF2015\CG150178\Drawings\CG150178-TR-DG-2502.dgn

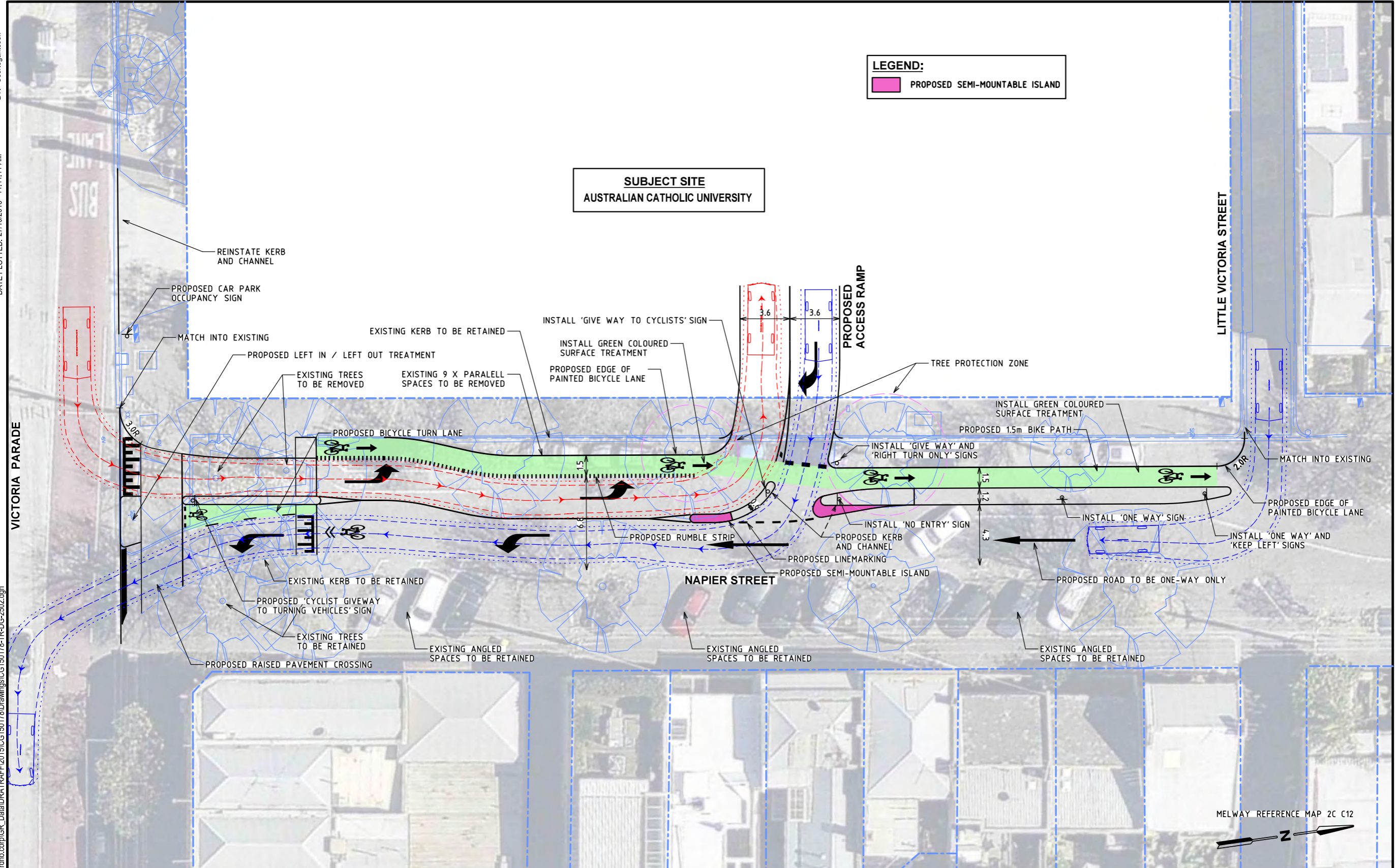

LEGEND:
 PROPOSED SEMI-MOUNTABLE ISLAND

SUBJECT SITE
 AUSTRALIAN CATHOLIC UNIVERSITY

MELWAY REFERENCE MAP 2C C12

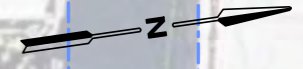

Rev	Date	Description	Drawn	Appr.
4	05.10.2016	COUNCIL COMMENTS	CS	SM
3	11.10.2016	COUNCIL COMMENTS	TR	SM
2	07.10.2016	CLIENT COMMENTS	EG	SM
1	27.09.2016	ISSUED FOR INFORMATION	CS	JPM

© Cardno Limited All Rights Reserved.
 This document is produced by Cardno Limited solely for the benefit of and use by the client in accordance with the terms of the retainer. Cardno Limited does not and shall not assume any responsibility or liability whatsoever to any third party arising out of any use or reliance by third party on the content of this document.

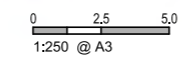

WARNING
 BEWARE OF UNDERGROUND SERVICES
 THE LOCATIONS OF UNDERGROUND SERVICES SHOWN ARE APPROXIMATE ONLY AND THEIR EXACT POSITION SHOULD BE PROVEN ON SITE.

1. BASE INFORMATION SUPPLIED BY BOSCO JONSON PTY LTD, REF No. 29460 AND NEARMAP AERIAL PHOTOGRAPHY. (BASE INFORMATION IS PARTIALLY INDICATIVE, SUBJECT TO FULL FEATURE SURVEY)
 2. ALL DIMENSIONS TO FACE OF KERB AND CHANNEL U.N.O
 3. DECLARED ROAD - VICTORIA PARADE (SPEED ZONE 60KM/H) LOCAL ROAD - NAPIER STREET (SPEED ZONE 50KM/H)
 4. LINE MARK IN ACCORDANCE WITH VICROADS TEM VOLUME 2 AND REMOVE ALL REDUNDANT LINEMARKING.

ABN: 47 106 610 913
 501 Swanston Street, Melbourne, VIC Australia 3000
 Phone (+61 3) 8415 7777 Fax (+61 3) 8415 7788
 Email: victoria@cardno.com.au Web: www.cardno.com.au/victoria

Drawn	C.SANSTOUPET
Designed	C.SANSTOUPET
Checked	JP.MAINA
Authorised	JP.MAINA

Client: AUSTRALIAN CATHOLIC UNIVERSITY
 Project: AUSTRALIAN CATHOLIC UNIVERSITY NAPIER STREET, FITZROY CITY OF YARRA
 Title: SIGNAGE AND LINEMARKING PLAN FUNCTIONAL LAYOUT PLAN OPTION 02

Status	PRELIMINARY		
	NOT TO BE USED FOR CONSTRUCTION PURPOSES		
Date	11.10.2016	Scale	1:250
Size	A3	Revision	4
Drawing Number	CG150178-TR-DG-2502		



Australian Catholic University,
St. Patricks Campus, Fitzroy

APPENDIX

B

BICYCLE PARKING
PRODUCTS





Anaconda™



Galvanised finish

Features



Anaconda rails are a freestanding version of the Flat Top. These are an excellent solution for use on asphalt or for temporary event parking. Available in a variety of materials and finishes in both adult and junior sizes.

- Easy to use with any bike lock
- Freestanding, self-supporting and can be fastened to all surfaces
- Using clamp-on elbows to join the rails
- Powder coated, galvanised, alloy or stainless steel rail tubing available
- Parks two bicycles per rail in either parallel or diagonal set up
- Supports all styles of bicycles in an upright position

Dimensions

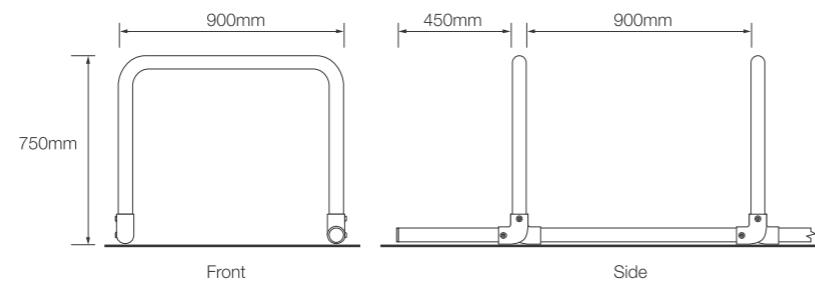

Specifications

Material options

- 316 Marine grade stainless steel
- Galvanised
- Powder coated
- Alloy

Fixing options

- Clamp on

Recommended fasteners

- Zinc plated Dynabolts (M10 x 65mm)
- Stainless Dynabolts (M10 x 65mm)

Dimensions

900mm [w] x 750mm [h]

Locking points

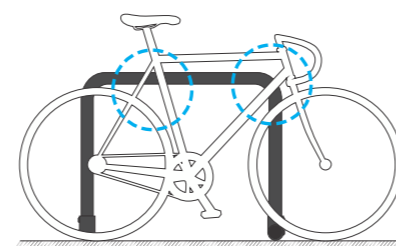

V1.1 - 18/01/2015 | Specification may be subject to change without notice. ©2015 Bicycle Network

Design. Supply. Install.

Bicycle Network ABN 41 026 835 903
p. 1300 727 563 e. parking@bicyclenetwork.com.au bikeparking.com.au
VIC Level 4, 246 Bourke St, Melbourne 3000 NSW 234 Crown St, Darlinghurst 2010
TAS 210 Collins St, Hobart 7000



Fixing options

Fix to the ground with Ground Tabs fitted over the piping at each end and secured with 8mm Allen bolts. Use either a Fastener or Ground Peg to secure the Anaconda to the ground.

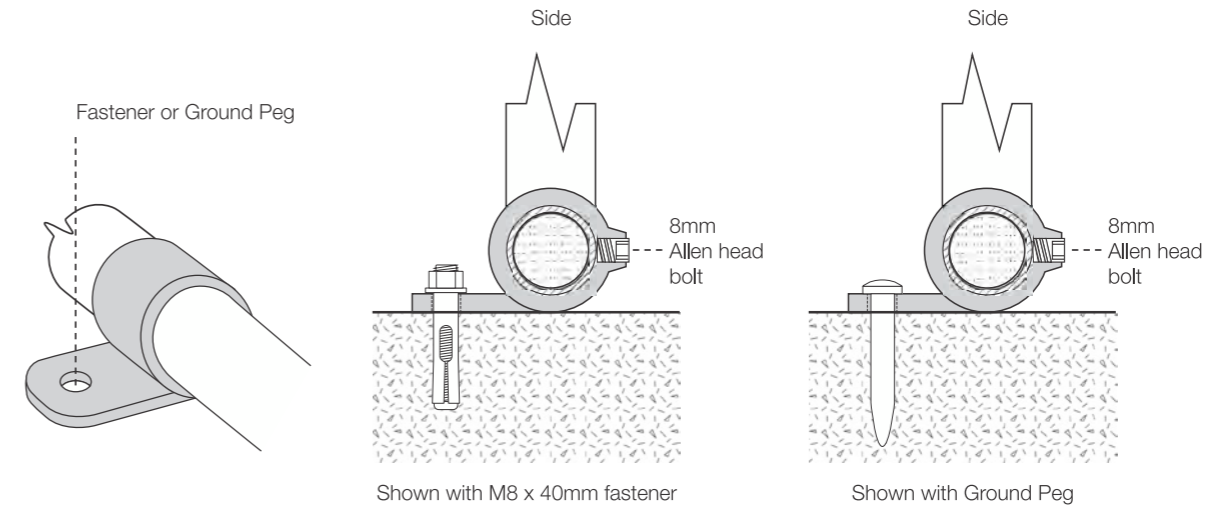

Layout guidelines

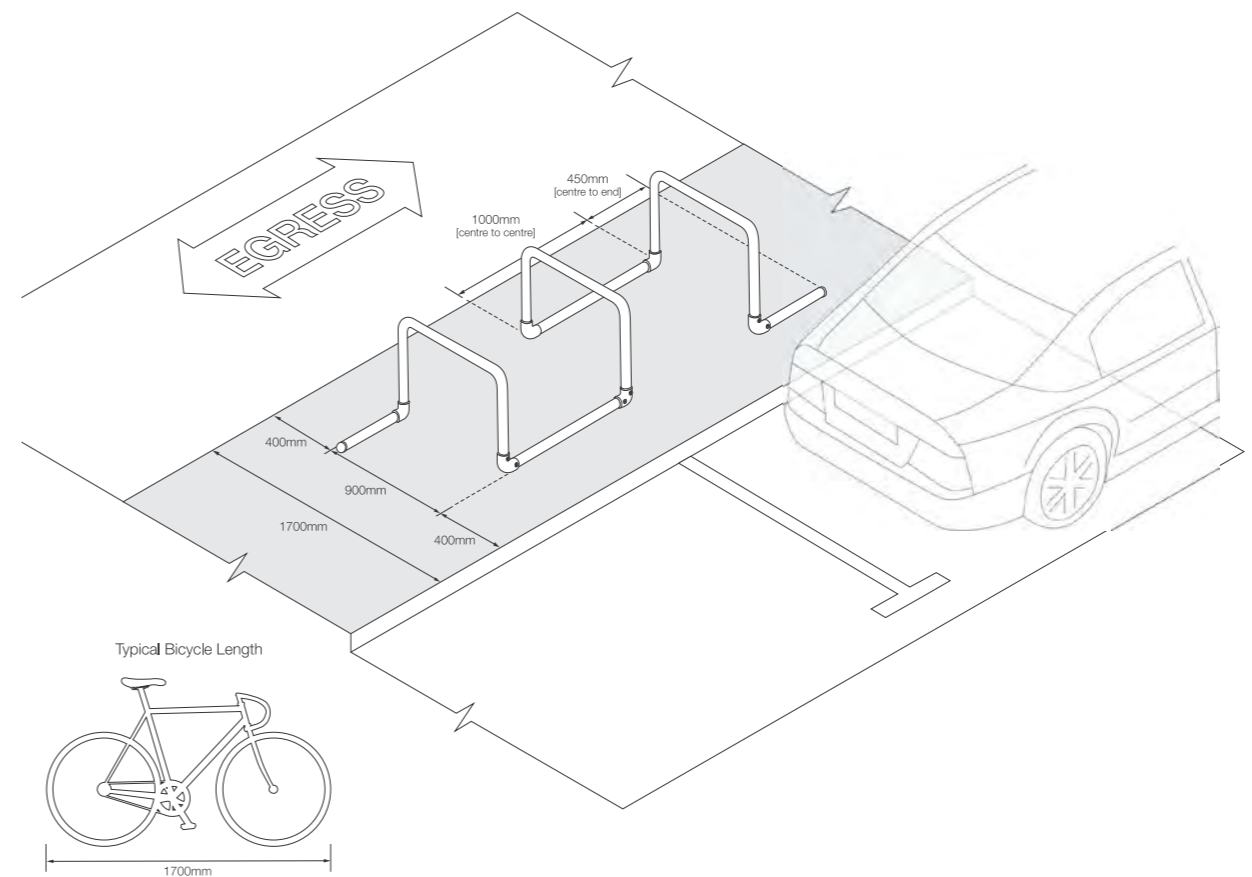

V1.1 - 18/01/2015 | Specification may be subject to change without notice. ©2015 Bicycle Network

Design. Supply. Install.

Bicycle Network ABN 41 026 835 903
p. 1300 727 563 e. parking@bicyclenetwork.com.au bikeparking.com.au
VIC Level 4, 246 Bourke St, Melbourne 3000 NSW 234 Crown St, Darlinghurst 2010
TAS 210 Collins St, Hobart 7000





Arc de Triomphe™



Stainless steel finish

Features



- Each rail supports two adult bikes in an upright position
- Can be either bolted to a concrete slab or concreted in situ
- Available in stainless steel or galvanised steel
- Provides the ability to lock both wheels and frame
- Suitable for foyers and entry areas

Dimensions

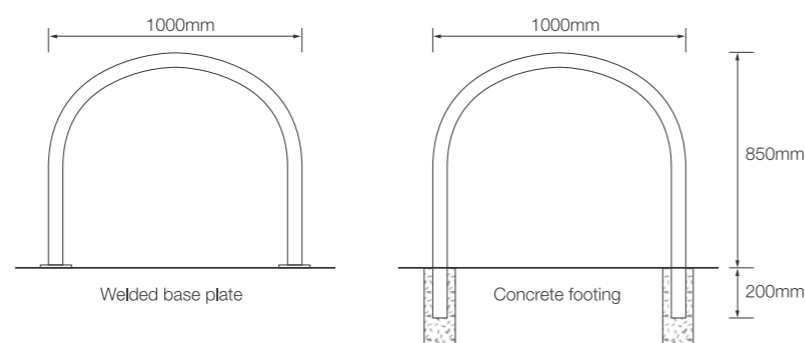

Specifications

Material options

- 316 Marine grade stainless steel
- Galvanised

Fixing options

- Welded flange
- In situ

Recommended fasteners

- Galvanised Dynabolts (M10 x 65mm)
- Stainless Dynabolts (M10 x 65mm)
- Shear Nut security fasteners

Dimensions

1000mm [w] x 850mm [h]

Locking points

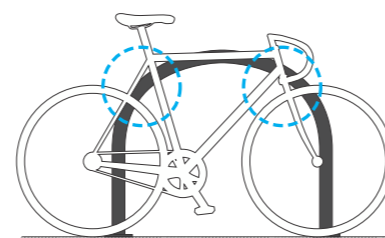

V1.1 - 18/01/2015 | Specification may be subject to change without notice. ©2015 Bicycle Network

Design. Supply. Install.

Bicycle Network ABN 41 026 835 903
p. 1300 727 563 e. parking@bicyclenetwork.com.au bikeparking.com.au
VIC Level 4, 246 Bourke St, Melbourne 3000 NSW 234 Crown St, Darlinghurst 2010
TAS 210 Collins St, Hobart 7000



Fixing options

In situ (Concrete footing)

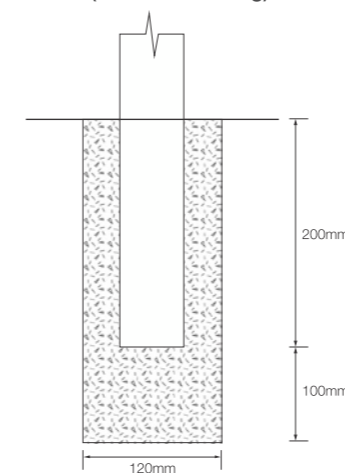

Welded flange (Bolt on)

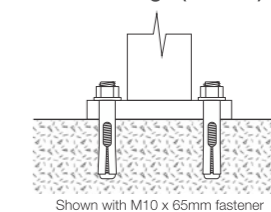

Welded flange (Security heads)

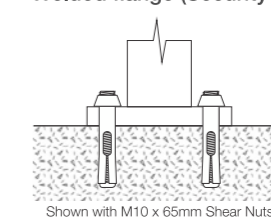

Layout guidelines

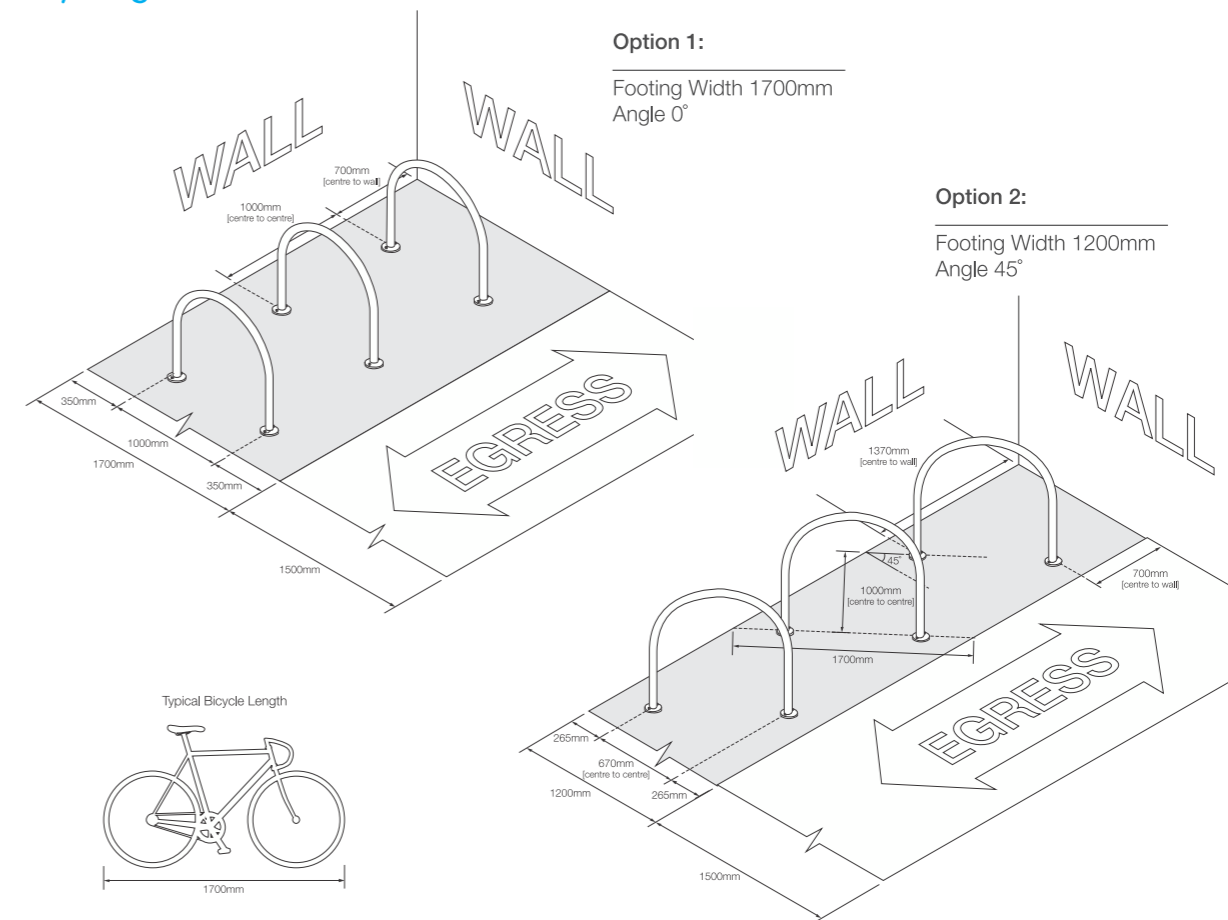

Design. Supply. Install.

Bicycle Network ABN 41 026 835 903
p. 1300 727 563 e. parking@bicyclenetwork.com.au bikeparking.com.au
VIC Level 4, 246 Bourke St, Melbourne 3000 NSW 234 Crown St, Darlinghurst 2010
TAS 210 Collins St, Hobart 7000



V1.1 - 18/01/2015 | Specification may be subject to change without notice. ©2015 Bicycle Network



Flat Top™



Stainless steel finish

Features



- Each rail supports two adult bikes in an upright position
- Can be either bolted to a concrete slab or concreted in situ
- Available in stainless steel or galvanised steel
- Provides the ability to lock both wheels and frame
- Suitable for interior use including storage cages

Specifications

Material options

- 316 Marine grade stainless steel
- Galvanised

Fixing options

- Welded flange
- In situ

Recommended fasteners

- Galvanised Dynabolts (M10 x 65mm)
- Stainless Dynabolts (M10 x 65mm)
- Shear Nut security fasteners

Dimensions

950mm [w] x 750mm [h]

Locking points

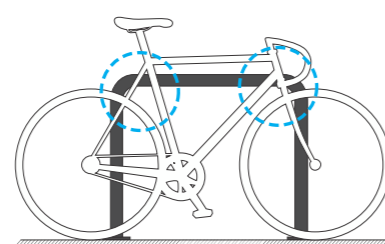

Dimensions

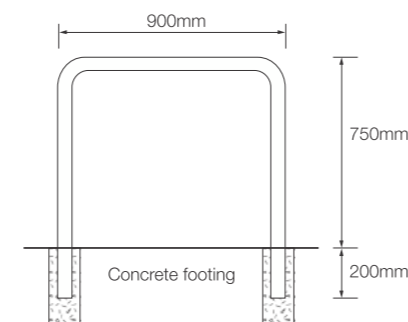
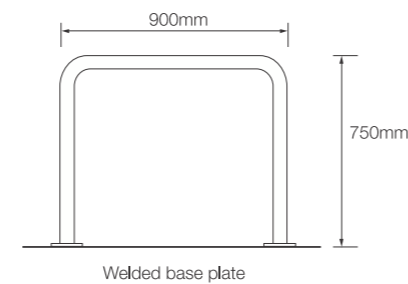

V1.1 - 18/01/2015 | Specification may be subject to change without notice. ©2015 Bicycle Network

Design. Supply. Install.

Bicycle Network ABN 41 026 835 903
p. 1300 727 563 e. parking@bicyclenetwork.com.au bikeparking.com.au
VIC Level 4, 246 Bourke St, Melbourne 3000 NSW 234 Crown St, Darlinghurst 2010
TAS 210 Collins St, Hobart 7000



Fixing options

In situ (Concrete footing)

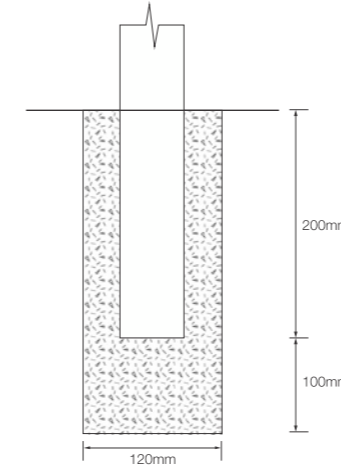

Welded flange (Bolt on)

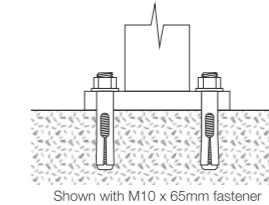

Welded flange (Security heads)

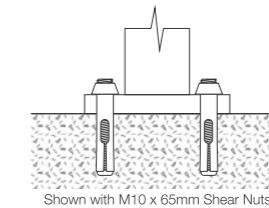

Layout guidelines

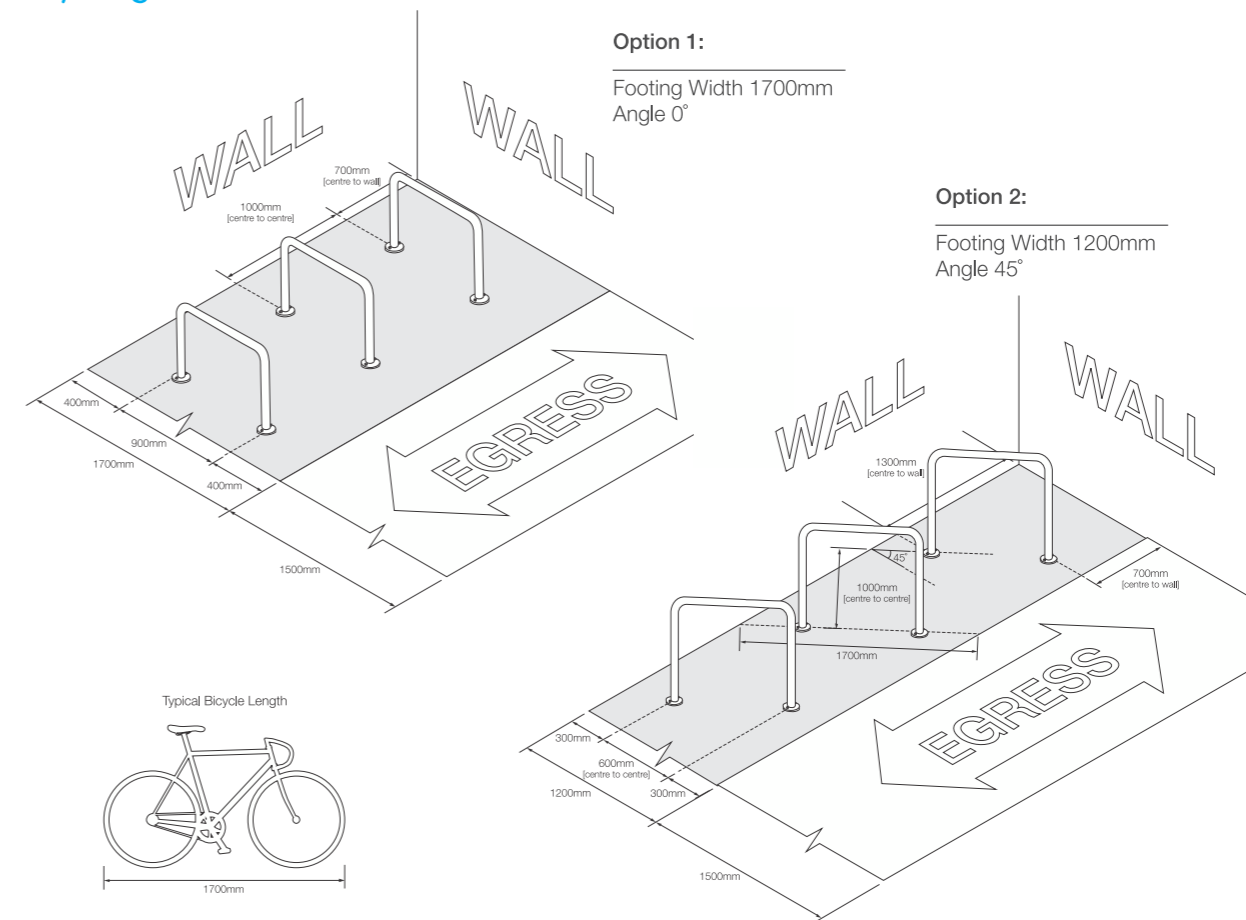

V1.1 - 18/01/2015 | Specification may be subject to change without notice. ©2015 Bicycle Network

Design. Supply. Install.

Bicycle Network ABN 41 026 835 903
p. 1300 727 563 e. parking@bicyclenetwork.com.au bikeparking.com.au
VIC Level 4, 246 Bourke St, Melbourne 3000 NSW 234 Crown St, Darlinghurst 2010
TAS 210 Collins St, Hobart 7000





Ned Kelly[®]™



Galvanised finish

Black powder coat finish

Features



- Each rail provides storage for a single bike
- Suits bikes with full length mud guards
- Available in galvanised or powder coat over mild steel
- Provides the ability to lock the main frame and one wheel
- Support prongs with protective coating prevent damage to rim
- Can be used with custom framing – no wall needed

Dimensions

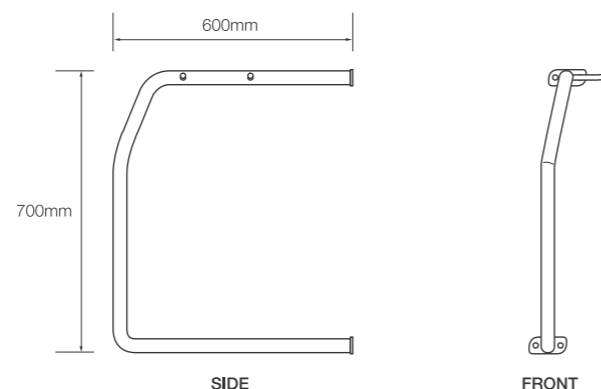

Specifications

Material options

- Galvanised
- Powder coat over mild steel
- Stainless steel*

Fixing options

- Bolt on to wall
- Fixed to support framing

Recommended fasteners – wall

- Dynabolts (M8 x 40mm)
- Shear Nut security fasteners

Recommended fasteners – framing

- Bolt and nut (M10 x 60mm)
- Tek screws

Dimensions

125mm [w] x 700mm [h] x 600mm [d]

* Pre-order only

Locking points

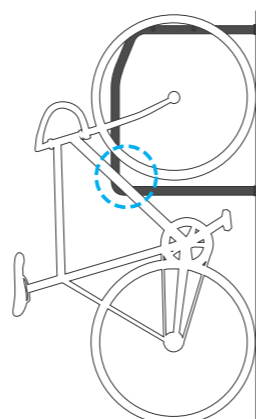

V1.1 - 18/01/2015 | Specification may be subject to change without notice. ©2015 Bicycle Network

Design. Supply. Install.

Bicycle Network ABN 41 026 835 903
p. 1300 727 563 e. parking@bicyclenetwork.com.au bikeparking.com.au
VIC Level 4, 246 Bourke St, Melbourne 3000 NSW 234 Crown St, Darlinghurst 2010
TAS 210 Collins St, Hobart 7000



Fixing options

Fix to a wall using 4x fasteners or Shear Nuts

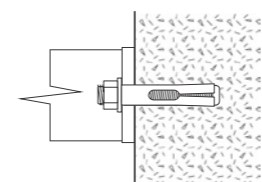

Shown with M8 x 40mm fastener

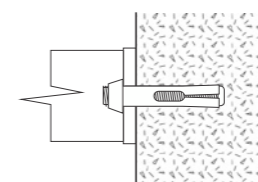

Shown with M8 x 40mm Shear Nuts

Fix to a frame using 4x bolts or Tek Screws

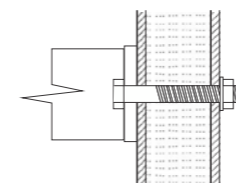

Shown with M10 x 60mm Bolt, Washer & Nut

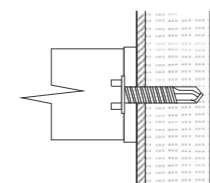

Shown with Tek Screw

Layout guidelines

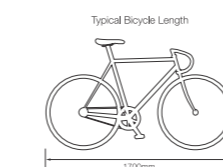
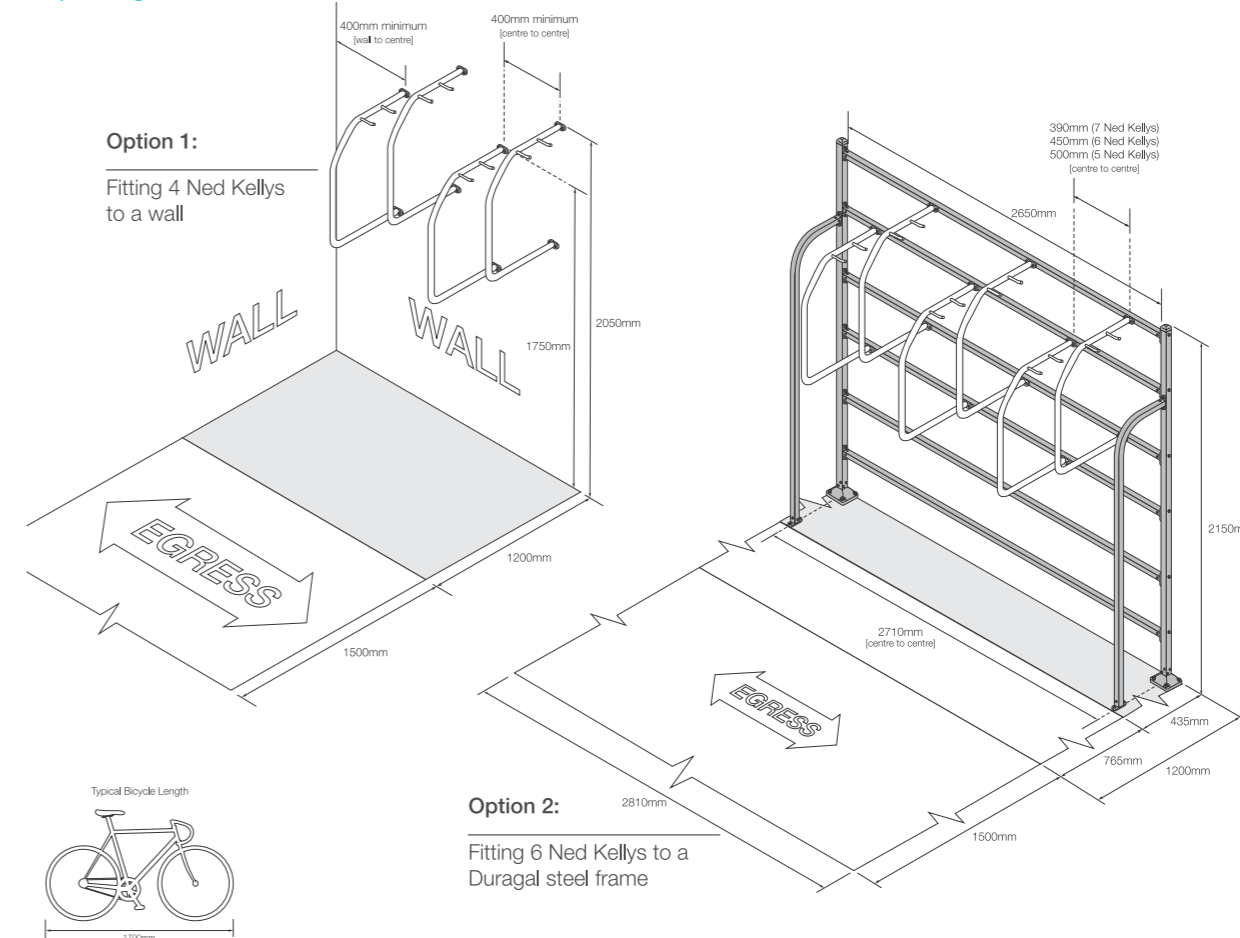

V1.1 - 18/01/2015 | Specification may be subject to change without notice. ©2015 Bicycle Network

Design. Supply. Install.

Bicycle Network ABN 41 026 835 903
p. 1300 727 563 e. parking@bicyclenetwork.com.au bikeparking.com.au
VIC Level 4, 246 Bourke St, Melbourne 3000 NSW 234 Crown St, Darlinghurst 2010
TAS 210 Collins St, Hobart 7000





Pole Vault™



Stainless finish

Features



The Pole Vault is an innovative street sign mounted bike parking rail that can be fitted in minutes with no drilling or concrete required.

- Can be retro-fitted to existing sign poles
- Accommodates a wide range of sizes and styles of bikes
- Can be moved and re-fitted to different locations
- Comes in standard galvanised, powdercoat or stainless material
- Easy to use with any bike lock
- Supports the entire bike so it won't slip or fall over

Dimensions

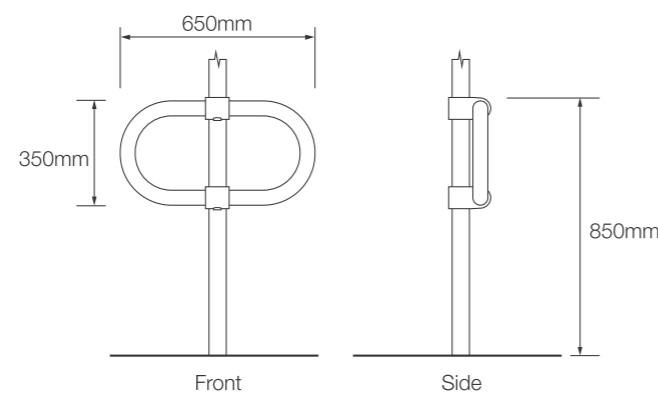

Specifications

Material options

- 316 Marine grade stainless steel
- Galvanised

Fixing options

- Clamp on

Recommended fasteners

- 8mm Allen head bolts

Dimensions

650mm [w] x 350mm [h]

Locking points

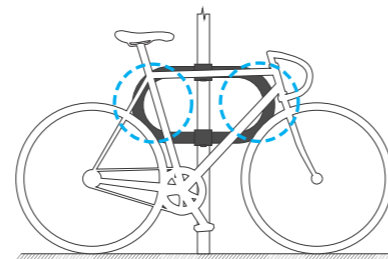

V1.1 - 18/01/2015 | Specification may be subject to change without notice. ©2015 Bicycle Network

Design. Supply. Install.

Bicycle Network ABN 41 026 835 903
p. 1300 727 563 e. parking@bicyclenetwork.com.au bikeparking.com.au
VIC Level 4, 246 Bourke St, Melbourne 3000 NSW 234 Crown St, Darlinghurst 2010
TAS 210 Collins St, Hobart 7000



Fixing options

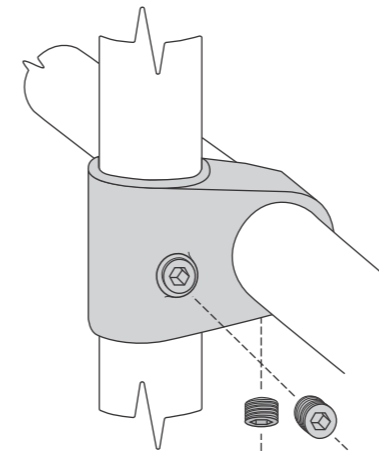

2 x 8mm Allen head bolts per clamp

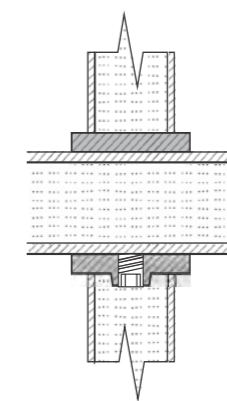

Front

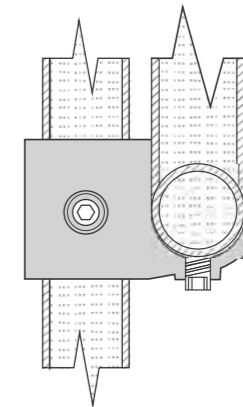

Side

Layout guidelines

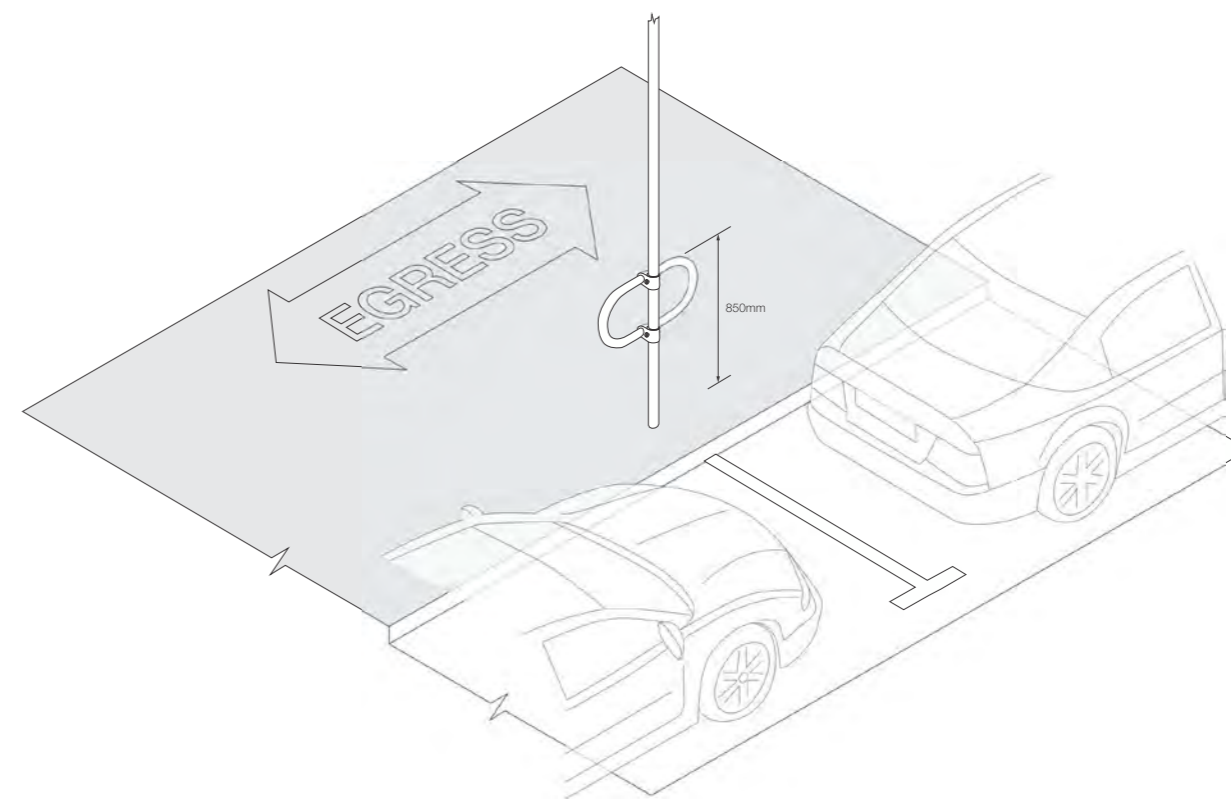

V1.1 - 18/01/2015 | Specification may be subject to change without notice. ©2015 Bicycle Network

Design. Supply. Install.

Bicycle Network ABN 41 026 835 903
p. 1300 727 563 e. parking@bicyclenetwork.com.au bikeparking.com.au
VIC Level 4, 246 Bourke St, Melbourne 3000 NSW 234 Crown St, Darlinghurst 2010
TAS 210 Collins St, Hobart 7000



Bike Parking Experts | Pole Vault™



Towel Hitching™



Zinc treated finish

Features



The Towel Rail is a space-efficient solution for parking single bikes against a wall, useful in narrow corridors.

- Space-efficient, can be fitted to narrow corridors
- Can be supplied in powdercoat or galvanised finish
- Accommodates all types and sizes of bicycle
- Is easy to use with any bike lock
- Requires no lifting

Dimensions

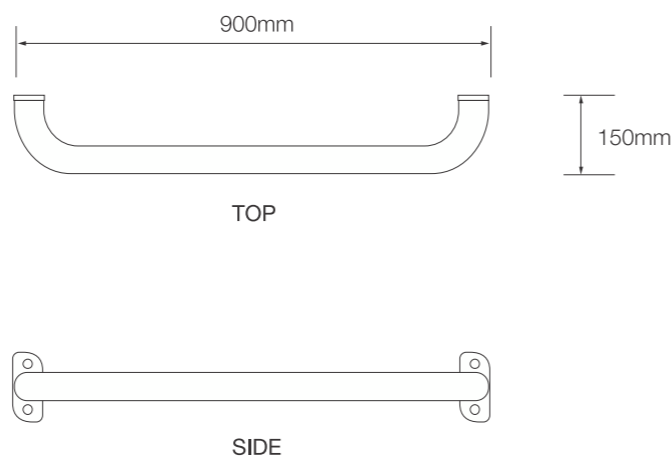

Specifications

Material options

- Powder coated
- Stainless steel
- Zinc treated
- Galvanised

Fixing options

- Welded flange - Bolt On

Recommended fasteners

- Zinc plated dynabolts (M8 x 40mm)

Dimensions

900mm [w] x 150mm [d]

Locking points

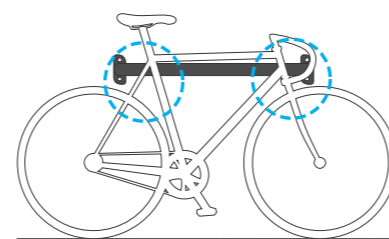

V1.1 - 18/01/2015 | Specification may be subject to change without notice, ©2015 Bicycle Network

Design. Supply. Install.

Bicycle Network ABN 41 026 835 903
p. 1300 727 563 e. parking@bicyclenetwork.com.au bikeparking.com.au
VIC Level 4, 246 Bourke St, Melbourne 3000 NSW 234 Crown St, Darlinghurst 2010
TAS 210 Collins St, Hobart 7000



Fixing options

Fix to a wall using 4x fasteners or Shear Nuts

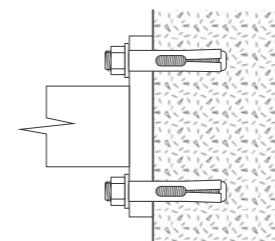

Shown with M8 x 40mm fastener

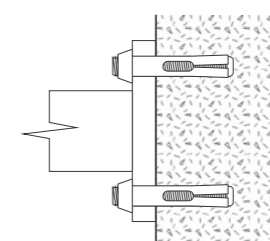

Shown with M8 x 40mm Shear Nuts

Layout guidelines

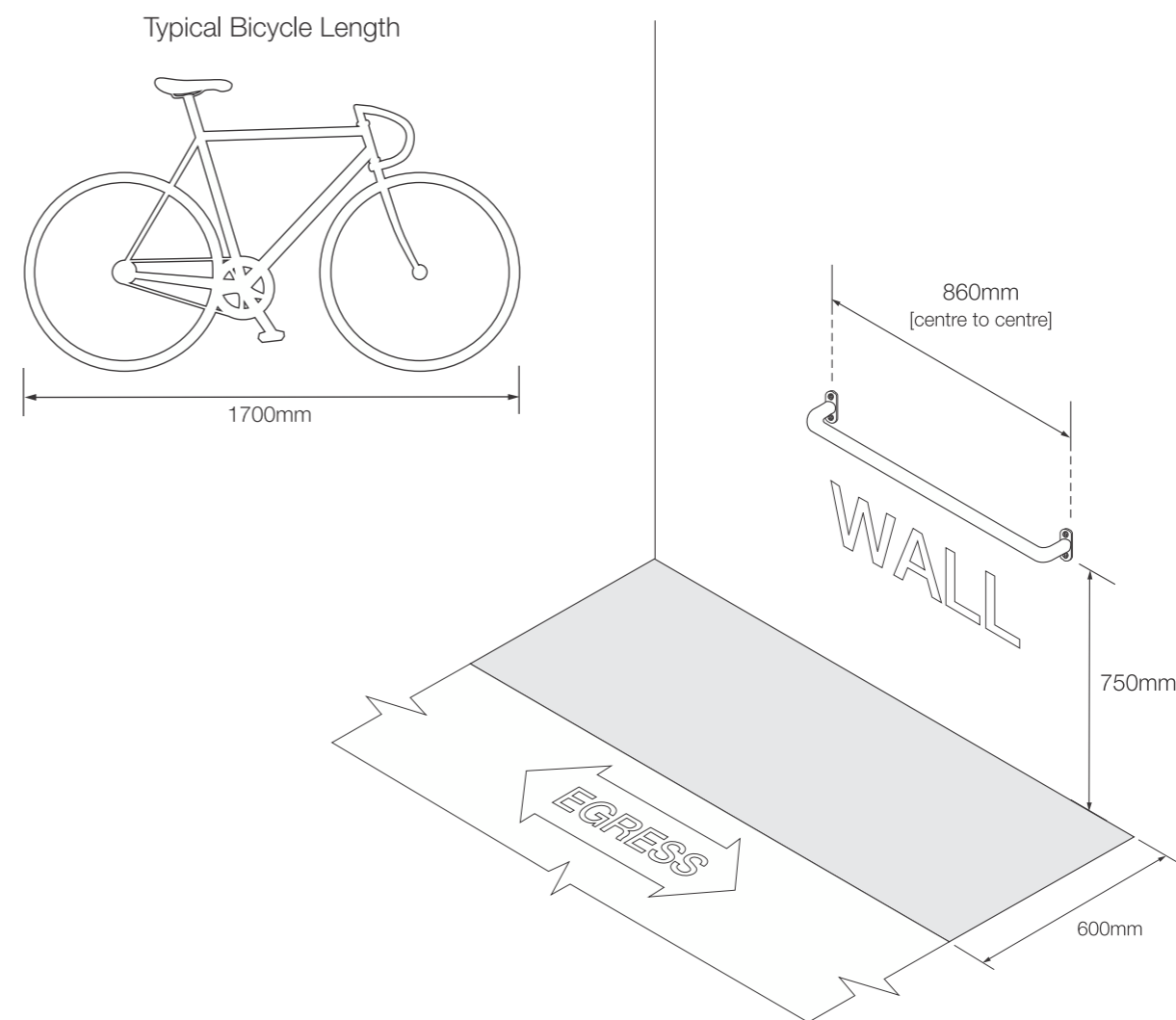

V1.1 - 18/01/2015 | Specification may be subject to change without notice, ©2015 Bicycle Network

Design. Supply. Install.

Bicycle Network ABN 41 026 835 903
p. 1300 727 563 e. parking@bicyclenetwork.com.au bikeparking.com.au
VIC Level 4, 246 Bourke St, Melbourne 3000 NSW 234 Crown St, Darlinghurst 2010
TAS 210 Collins St, Hobart 7000



Wind Microclimate Assessment

Pedestrian comfort at 115B Victoria Parade

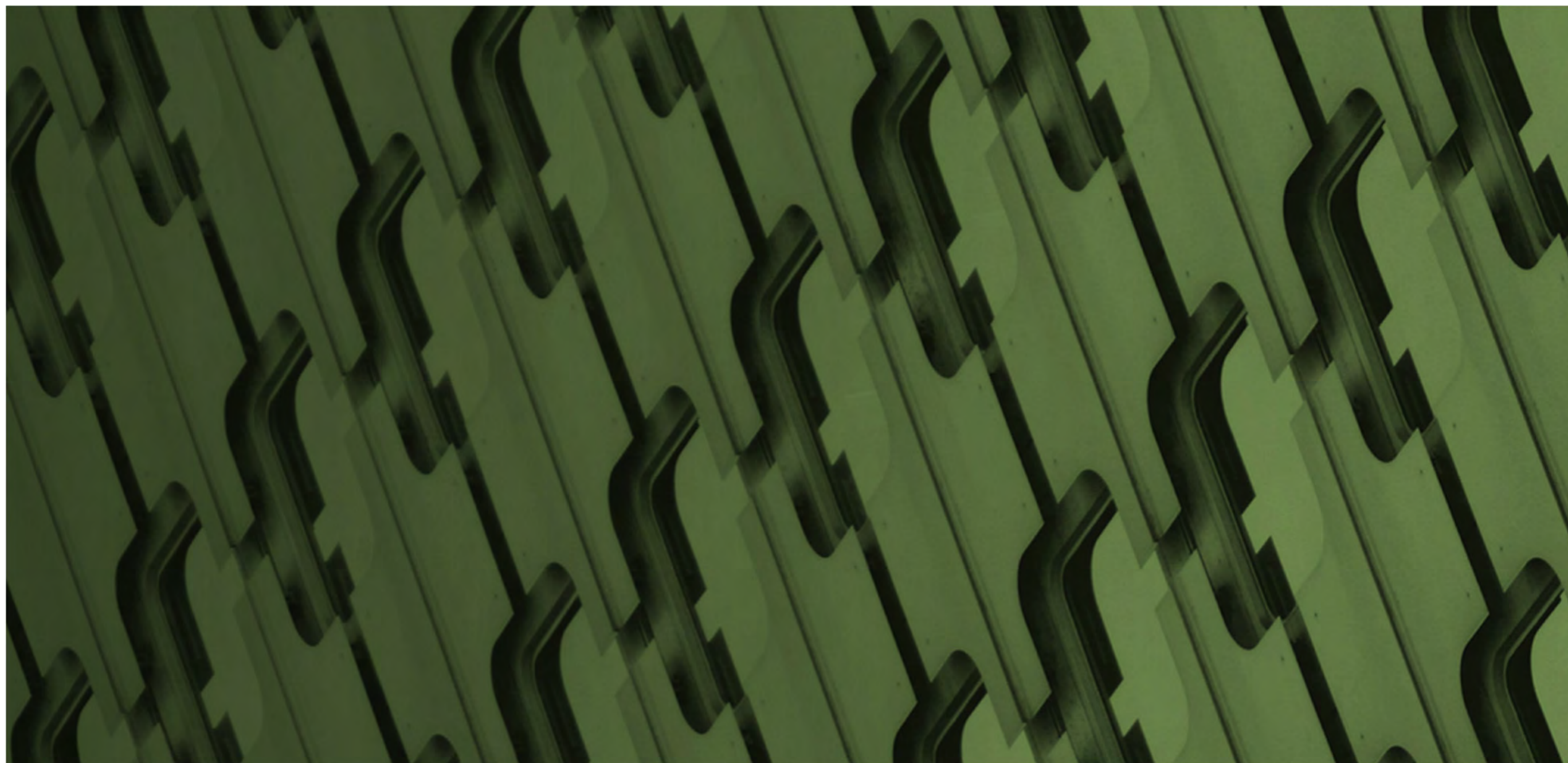

AECOM

Australian Catholic University Melbourne Campus Development
Wind Microclimate Assessment
Commercial-in-Confidence

Wind Microclimate Assessment

Pedestrian comfort at 115B Victoria Parade

Client: Australian Catholic University

ABN: 15050192660

Prepared by

AECOM Australia Pty Ltd
Level 10, Tower Two, 727 Collins Street, Melbourne VIC 3008, Australia
T +61 3 9653 1234 F +61 3 9654 7117 www.aecom.com
ABN 20 093 846 925

19-Oct-2016

Job No.: 60519200

AECOM in Australia and New Zealand is certified to ISO9001, ISO14001 AS/NZS4801 and OHSAS18001.

© AECOM Australia Pty Ltd (AECOM). All rights reserved.

AECOM has prepared this document for the sole use of the Client and for a specific purpose, each as expressly stated in the document. No other party should rely on this document without the prior written consent of AECOM. AECOM undertakes no duty, nor accepts any responsibility, to any third party who may rely upon or use this document. This document has been prepared based on the Client's description of its requirements and AECOM's experience, having regard to assumptions that AECOM can reasonably be expected to make in accordance with sound professional principles. AECOM may also have relied upon information provided by the Client and other third parties to prepare this document, some of which may not have been verified. Subject to the above conditions, this document may be transmitted, reproduced or disseminated only in its entirety.

Quality Information

Document Wind Microclimate Assessment
60519200

Ref \\aumel1fp001\projects\605x\60519200\4. tech work area\4.3
esd\01_assessments\wind microclimate\161019_acu_wind microclimate
assessment_final.docx

Date 19-Oct-2016

Prepared by Nicki Parker

Reviewed by Sian Willmott

Revision History

Revision	Revision Date	Details	Authorised	
			Name/Position	Signature
0	19-Oct-2016	Issued for inclusion to Development Plan	Russell Evans Technical Director	

Table of Contents

Executive Summary	i
1.0 Introduction	1
1.1 Purpose, basis and limitations of this report	1
2.0 Assessment criteria	1
2.1 Basis	1
2.2 Comfort	1
3.0 The local wind climate	2
3.1 Meteorological data	2
3.2 Summary statistics	2
3.2.1 Wind speed	2
3.2.2 Wind direction	3
4.0 Comfort assessment	3
4.1 Wind-sensitive locations	3
4.1.1 Ground level outdoor seating area	4
4.1.2 Along Napier Street	4
4.1.3 Along Victoria Parade	4
4.1.4 Level 4 Terrace	4
4.1.5 Level 6 Terrace	4
4.1.6 Along Young Street	4
4.1.7 Along Little Victoria Street	4
5.0 Summary	5
5.1 Likelihood of discomfort	5
5.2 Mitigation	5
Bibliography	6

Executive Summary

This report assesses the likelihood that wind-induced discomfort may be felt by patrons of various outdoor spaces around the proposed 115B Victoria Parade development for the Australian Catholic University. The assessment draws on a large local meteorological data set adjusted for location and height.

Winds are assessed against the Lawson comfort criteria, which sets upper wind speeds for comfort during a range of typical activities — long-term sedentary (e.g. sitting at café tables), short-term sedentary (e.g. queuing, talking), slow movement (e.g. window shopping, strolling), and rapid movement (e.g. fast walking).

Based on hourly wind speed and direction data collected from the Melbourne Regional Office (located approximately 1km to the west of the site), predominant winds are west south westerly and north easterly throughout the year and during business hours, as well as outside of business hours. These two key wind directions have therefore been the focus of the analysis provided for this submission.

Seven locations within and around the site have been identified as being sensitive to wind speed. These are summarised in the table below, along with the desired wind comfort and activity category. Potential issues have been highlighted.

Table 1: Wind assessment summary and impacts

Location	Desired wind comfort and activity category	Potential wind microclimate impacts
1 Ground level outdoor seating around within the site boundary	Comfortable for pedestrians sitting or standing for longer periods of time	Channelling of winds along Victoria Parade – some local mitigation may be required.
2 Along Napier Street	Comfortable for pedestrians leisure walking	Unlikely to be significant impacts caused by the proposed building.
3 Along Victoria Parade	Comfortable for pedestrians leisure walking	Unlikely to be significant impacts caused by the proposed building.
4 Level 4 Terrace	Comfortable for pedestrians sitting or standing for shorter periods of time	Exposed to predominant winds – balustrades likely to provide sufficient protection.
5 Level 6 Terrace	Comfortable for pedestrians sitting or standing for shorter periods of time	Exposed to predominant winds – balustrades likely to provide some protection. Additional local mitigation may be required.
6 Along Young Street	Comfortable for pedestrians leisure walking	Unlikely to be significant impacts caused by the proposed building.
7 Along Little Victoria Street	Comfortable for pedestrians leisure walking	Unlikely to be significant impacts caused by the proposed building.

Due to the relatively low wind speeds experienced in this area of Melbourne, there are unlikely to be any significant adverse impacts at Ground Level within or surrounding the site due to the construction of the proposed 115B Victoria Parade development. The staggered, non-uniform shape of the building envelope is likely to minimise wind acceleration, with horizontal shading further assisting in minimising potential issues.

A detailed computational analysis will be undertaken during the next design stage which will quantify expected wind speeds and compare these against the Lawson comfort criteria.

1.0 Introduction

It is somewhat inevitable that, with the construction of a new development, the wind microclimate in the vicinity will be changed. Where new buildings are significantly different in size and form, orientation or height from those in the immediate vicinity, winds can be introduced which may cause discomfort to pedestrians. The design of a development should therefore consider the provision of a quality outdoor environment, which is appropriate for its designated use for the majority of the year. Due to the height and layout of the proposed building at 115B Victoria Parade, a number of potentially adverse wind effects may be experienced.

This study is an experience based qualitative review of the pedestrian level wind environment around the proposed 115B Victoria Parade development. The assessment of wind conditions is based upon our experience with other similar schemes and our knowledge of the interaction of the wind with the built environment. The wind conditions around the proposed development in relation to planned pedestrian activities have been considered and an assessment of the potential impact that the proposed development may have on the surrounding area's wind microclimate is provided. Areas where wind is likely to be accelerated by geometrical features are highlighted and ways to mitigate these effects are recommended.

Local authority planning guidelines typically focus on user comfort and safety. Here, users are usually taken to be at ground level (or the main podium level etc.) of a particular space. They may be passing through on foot or bicycle; wandering slowly (e.g. talking); sitting or standing for a short period (e.g. at a bus stop) or for a long period (e.g. outdoor dining). Planning criteria focus on the frequency of high winds, which are known to be uncomfortable in various situations and for various durations of exposure.

Upper-level users of balconies etc. may also be affected by winds, but exposure is generally considered to be by choice and easily avoidable. In rare cases, outdoor dining or other regular outdoor activity may take place relatively high above ground level, in which case special assessments must be made.

As this is a desk based study, quantification of likely increases or decreases in wind speed cannot be given and only an indication of likely conditions that pedestrians will experience is presented here.

1.1 Purpose, basis and limitations of this report

The purpose of this report is to provide evidence as to the likelihood of wind-induced discomfort to ground-level users of the spaces around the building.

This report presents probabilistic estimates of the likelihood of events which may have comfort implications. These are based on historical wind data and measured against commonly available wind effects criteria using accepted estimated methods. Given these limitations, AECOM cannot guarantee with certainty that the development will not adversely impact upon safety and comfort in the public realm.

This report is based on drawings and other information supplied; a statistical analysis of data; published methodologies for wind assessment; and experience with assessing wind flows around buildings. The statistical analysis does not include an allowance for rare high-wind events such as severe storms. Also note that future wind patterns may not reflect past wind patterns. For example, changes in wind climate due to global warming are not accounted for. This report does not address structural aspects of wind phenomena.

All advice is provided with best intent and to the accuracy limits of the nature of the assessment undertaken.

2.0 Assessment criteria

2.1 Basis

Wind speed and gustiness are the primary measurable factors affecting people's comfort. Other factors such as air temperature and humidity, clothing, sun exposure, etc. are also significant, but these can often be addressed by a modification of effective wind speeds (Twidell, 2006).

Wind speed is understood to mean the average wind speed taken over a time of one hour or so. Gustiness refers to the rate of change of wind speed, usually identified with the turbulent intensity defined by ratio of the standard deviation of the mean wind speed to the mean itself. The important wind gusts are those lasting 2–3 seconds, being the time taken to perform a simple act such as a few walking steps, opening a door etc.

Gustiness is a difficult factor to assess on the urban micro-scale. Fortunately, the implied turbulent intensity may be related to the underlying means in order to recast gustiness criteria in terms of mean wind speed (Twidell, 2006), (Melbourne, 1978), (ASHRAE, 2001), (Blocken, 2004). Estimates of turbulent intensity in urban situations range from 15% to 30% (Twidell, 2006), implying that gust wind speeds are generally 1.5–2.0 times greater than mean wind speeds.

2.2 Comfort

In general, comfort criteria relate to both the thermal effects of wind on people, and the mechanical effects of wind on their activities.

The comfort criteria used in this study is the Lawson criteria (Lawson, 1978), based on the probability of exceeding certain mean wind speeds. The criteria are presented in Table 2. Wind conditions are unacceptable when the probability of the mean wind speed exceeding the given number is greater than 5%.

Table 2: The Lawson wind comfort criteria

Threshold wind speed (m/s)	Activity
4	Uncomfortable for pedestrians in the vicinity of entrance doors or sitting outside for long periods of time, such as outdoor cafes.
6	Uncomfortable for pedestrians standing or sitting for shorter periods of time, such as queuing or talking.
8	Uncomfortable for pedestrians 'leisure walking' e.g. strolling, window shopping and sightseeing.
10	Uncomfortable for pedestrians walking quickly e.g. walking to a destination, and cycling.

3.0 The local wind climate

3.1 Meteorological data

The wind data was taken from the Bureau of Meteorology automatic weather station at Melbourne Regional Office (RO)¹, which is located on the corner of La Trobe Street and Victoria Parade, approximately 1km to the west of 115B Victoria Parade.

The wind speed data was rescaled to account for the difference in land surface structure between the meteorological station and the development site, and the height difference between the anemometer and the level at which people are affected (assumed to be 1.5m above ground level). The rescaling was accomplished using a logarithmic-law approximation to a neutrally stable atmospheric boundary layer profile (Pasquill-Gifford Class D) (Oke, 2006) using the equation:

$$u_z = \frac{u_*}{\kappa} \ln \frac{z}{z_0}$$

In which u_z is the wind speed at height z (1.5m for pedestrian height), u_* is the friction velocity which is based on the reference wind speed from Melbourne RO, κ is von Karman's constant ($\cong 0.4$) and z_0 is the roughness height (taken as 2m for this site to account for physical obstructions such as cars).

Wind speeds below 0.5 m/s are registered by the anemometer as zero (calm).

3.2 Summary statistics

The wind data was analysed to assess the likelihood of uncomfortable winds, without allowing for the presence of the development. Local wind effects due to the development will be discussed in the next section.

The analysis was carried out using:

- The entire data set, representing wind conditions 24 hours a day
- A subset restricted to the hours of 7am to 7pm (business hours) when outdoor areas would be most active

3.2.1 Wind speed

Calm conditions occur only rarely (5%) during business hours, slightly more frequently (8%) during winter. Wind speeds at pedestrian height are low compared to the comfort criteria (Figure 1 on the following page). Based on wind speeds experienced at the Melbourne RO, i.e. not taking in to account acceleration caused by the built environment local to 115B Victoria Parade, wind speeds are likely to be comfortable for long term sedentary activities for the majority of the time.

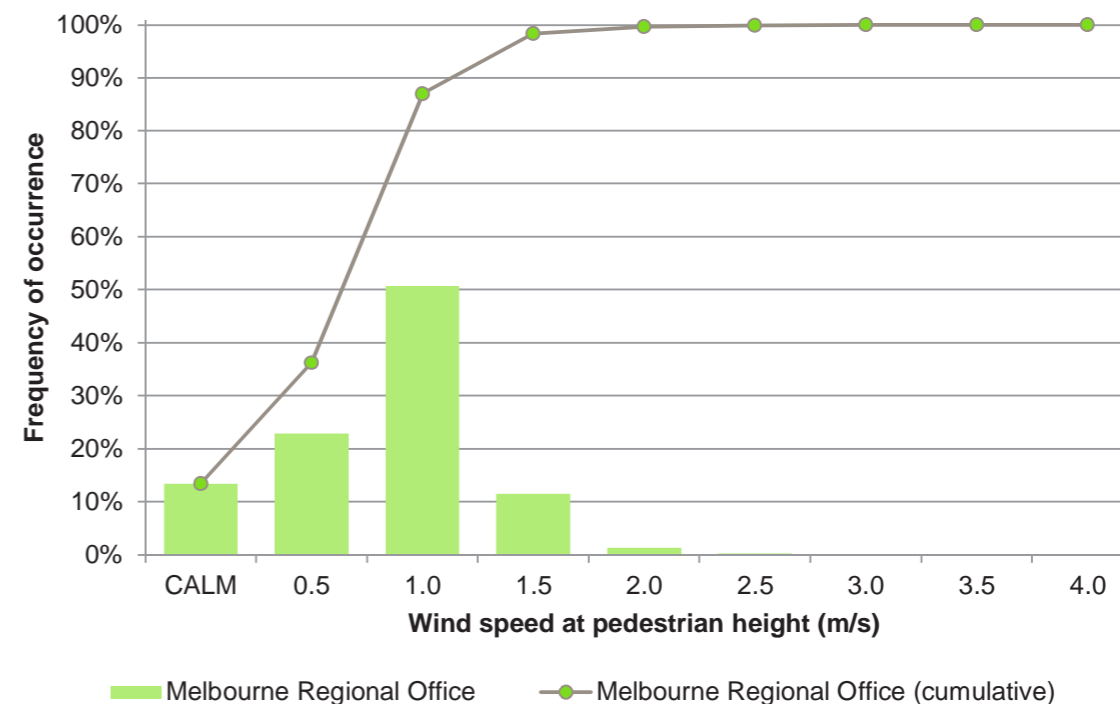

Figure 1: Distribution of wind speeds by band (bars) and cumulatively (line).

¹ Station number 086071. The data consisted of hourly wind speed and direction, maximum gust speed, temperature and other variables from 3/3/1997 to 31/8/2009. After quality checks, there were a total of 94,026 suitable records.

3.2.2 Wind direction

Figure 2 shows the frequency of winds from each direction (divided in to 10° increments) for all hours and seasons (top left), divided by season for all times of the day (top right) and divided by season during business hours (bottom). Within the CBD, there is very little variation in predominant winds between seasons, and during business hours and outside of business hours, with west south westerly winds occurring most frequently, closely followed by north easterly winds. Hence west south westerly and north easterly winds will be the focus of the assessment in section 4.0.

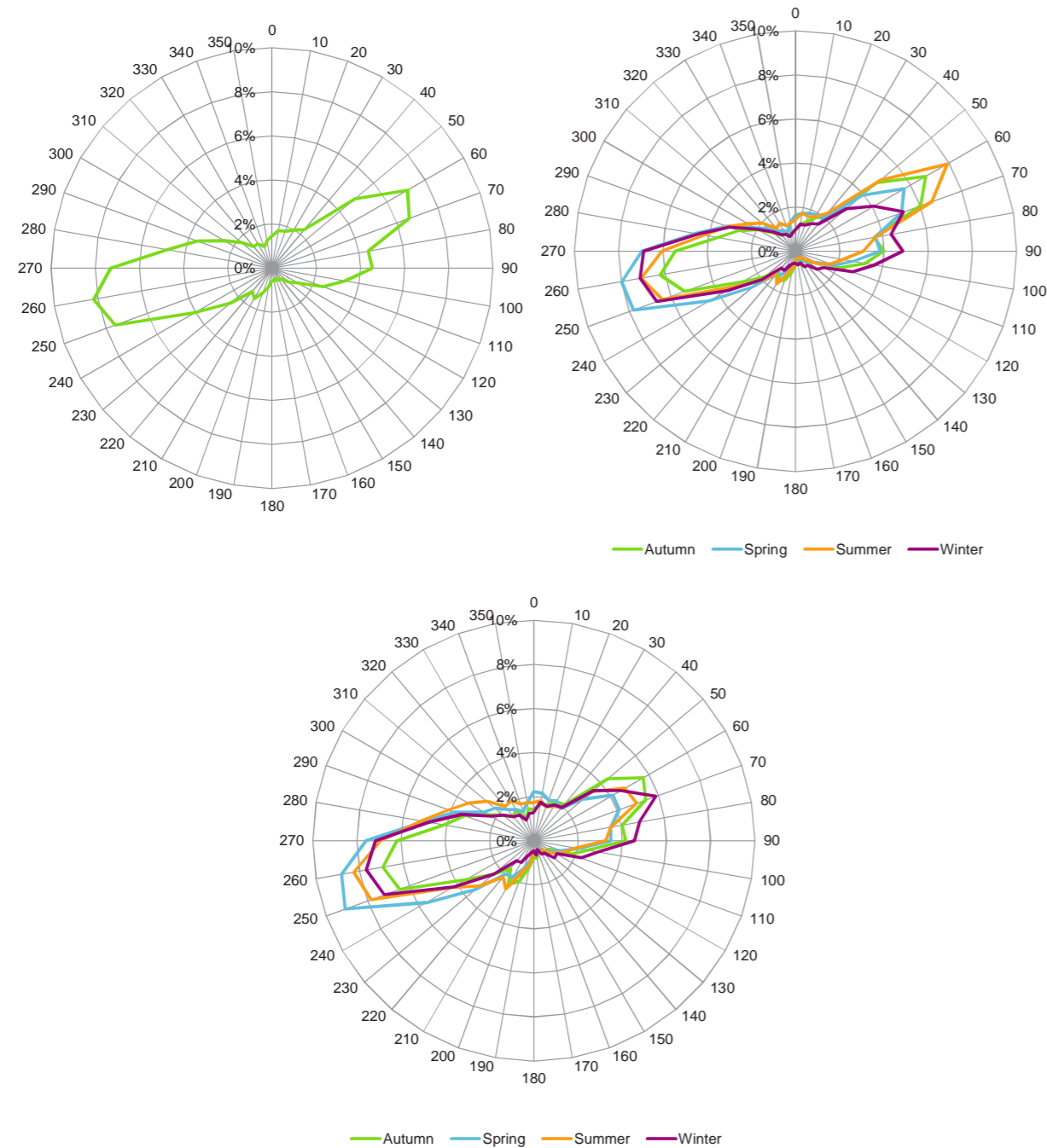

Figure 2: Distribution of wind heading for all times and seasons (top left), all times divided by season (top right), and by season during business hours (bottom).

4.0 Comfort assessment

4.1 Wind-sensitive locations

Figure 3 and Figure 4 identify the locations that are potentially sensitive to wind flows, both within the site boundary, and the impact that the proposed building may have on adjacent streets. Each location is discussed in the following sections.



1. Ground level outdoor seating area
2. Along Napier Street
3. Along Victoria Parade
4. Level 4 Terrace
5. Level 6 Terrace

Figure 3: View from south east

- 6. Along Young Street
- 7. Along Little Victoria Street



Figure 4: View from north west

4.1.1 Ground level outdoor seating area

This area is required to be comfortable for pedestrians sitting or standing for longer periods of time.

West south westerly winds are likely to channel along Victoria Parade from the city. Buildings on the opposite side of Victoria Parade are likely to provide little shelter, however winds are unlikely to be excessive in speed. Local mitigation features may be required, and this will be confirmed during the detailed analysis that will be carried out during the next design stage.

The adjacent buildings across Napier Street are likely to provide some shelter from north easterly winds, with down wash on the eastern façade unlikely due to the staggered floor plate of the buildings and horizontal fins used for provide shade.

4.1.2 Along Napier Street

Conditions along Napier Street should be suitable for leisure walking as a minimum. The proposed building is unlikely to accelerate wind speeds above this threshold, and more detailed analysis will be undertaken during the next stage of design in order to confirm this.

4.1.3 Along Victoria Parade

Conditions along Victoria Parade should be suitable for leisure walking as a minimum. The proposed building is unlikely to accelerate wind speeds above this threshold, and more detailed analysis will be undertaken during the next stage of design in order to confirm this.

4.1.4 Level 4 Terrace

The Level 4 Terrace should be suitable for shorter periods of sitting or standing, however exposure is generally considered to be by choice and easily avoidable.

The terrace area is exposed to north easterly winds with no shelter provided by surrounding buildings as they are all considerably lower than this level. The balustrades (currently shown at around 1.6m high) will provide protection to users of this space, and an estimate of likely wind speeds will be provided in the detailed analysis in the next stage of design.

4.1.5 Level 6 Terrace

As with Level 4, the Level 6 Terrace should be suitable for shorter periods of sitting or standing, however exposure is generally considered to be by choice and easily avoidable.

This terrace is exposed to both west south westerly winds and north easterly winds, and so has the potential to experience elevated winds compared to the Level 4 Terrace, due to the depth of the terrace. Again, the balustrades (currently shown at 1.6m high) will provide protection to users, and further analysis will be provided in the next design stage.

4.1.6 Along Young Street

Conditions along Young Street should be suitable for leisure walking as a minimum. The proposed building is unlikely to accelerate wind speeds above this threshold, and more detailed analysis will be undertaken during the next stage of design in order to confirm this.

4.1.7 Along Little Victoria Street

Conditions along Little Victoria Street should be suitable for leisure walking as a minimum. The proposed building is unlikely to accelerate wind speeds above this threshold, and more detailed analysis will be undertaken during the next stage of design in order to confirm this.

5.0 Summary

5.1 Likelihood of discomfort

A high level desktop study of likely wind conditions around the proposed 115B Victoria Parade building and surrounding streets has been undertaken. Due to the relatively low wind speeds experienced in this area of Melbourne, there are unlikely to be any significant adverse impacts at ground level within or surrounding the site due to the construction of this building. The staggered, non-uniform shape of the building envelope is likely to minimise wind acceleration, with horizontal shading further assisting in minimising potential issues.

The terraces on Levels 4 and 6 are relatively exposed to prevailing winds. Although the current balustrades will provide some protection, additional local mitigation measures may be required

A detailed computational analysis will be undertaken during the next design stage which will quantify expected wind speeds and compared these against the Lawson comfort criteria.

5.2 Mitigation

No additional mitigation requirements are proposed at this stage, however smaller local features may need to be incorporated following the detailed analysis.

Bibliography

- ASHRAE. (2001). *ASHRAE Handbook*.
- Blocken, B. a. (2004). Pedestrian wind environment around buildings: literature review and practical examples. *Journal of Thermal Environment and Building Science*, 107–159.
- Hunt, J. P. (1976). *The effects of wind on people: new criteria based upon wind tunnel experiments*, *Buildings and Environment*.
- Lawson, T. (1978). The Wind Content of the Built Environment. *Journal of Wind Engineering and Industrial Aerodynamics, Volume 3, Issues 2-3*, 93-105.
- Melbourne, W. (1978). Criteria for environmental wind conditions,, . *Journal of Industrial Aerodynamics 3*, 241–249.
- Oke, T. R. (2006). *Boundary Layer Climates*. TJ International Ltd, Padstow, Cornwall, Great Britain.
- Simiu, E. a. (1986). *Wind effects on structures, 2nd ed*. John Wiley & Sons.
- Twidell, J. a. (2006). *Renewable Energy Resources, 2nd edition*,.

**ARBORICULTURAL REPORT
ARBORICULTURAL IMPACT ASSESSMENT
AUSTRALIAN CATHOLIC UNIVERSITY
115B VICTORIA PARADE, FITZROY**

PREPARED BY

Simon Howe

Consultant Arborist

B.AppSci(Hort)

GradDip Plan&Des (LandscpArch) MELB

October 2016



LANDSCAPE ARCHITECTS
ENVIRONMENTAL HORTICULTURISTS
LANDSCAPE HERITAGE CONSULTANTS
CONSULTANT ARBORISTS

JOHN PATRICK LANDSCAPE ARCHITECTS PTY LTD

324 Victoria Street, Richmond, VIC 3121, Australia
T +61 3 9429 4855 E admin@johnpatrick.com.au
F +61 3 9429 8211 W www.johnpatrick.com.au

TABLE OF CONTENTS

1	Introduction	1
2	Discussion.....	1
3	Impact of proposed development.....	3
	Site Trees.....	3
	Trees Outside the Site	3
4	Site Photographs	5
5	Results of Tree Survey	9
6	Descriptors.....	16
7	Appendix 1 – Tree Location Plan.....	25

1 INTRODUCTION

1.1 Trees within and adjacent to the Australian Catholic University, 115B Victoria Parade, Fitzroy were assessed on the 15th September, 2016. Trees within the subject site as well as trees in adjacent road reserves (Young and Napier Streets, Victoria Parade) were assessed as part of the study.

2 DISCUSSION

2.1 32 trees or tree groups were assessed as part of this study:

- 10 trees or tree groups within the subject site have been assessed of medium retention value;
- 8 trees within the subject site have been assessed of low retention value;
- 14 trees have been assessed outside the subject site.

2.2 Of the ten trees assessed within the site of medium retention value, nine are semi-mature Pin Oaks within the car park in the east of the site. These are generally developing well within a highly urbanised environment. A pair of Bangalow Palms (Tree 1) are located adjacent to the north- west corner of the car park.

TABLE 1 Trees assessed of medium retention value

No	Species	Common Name
1	<i>Archontophoenix cunninghamiana</i>	Bangalow Palm
2	<i>Quercus palustris</i>	Pin Oak
3	<i>Quercus palustris</i>	Pin Oak
4	<i>Quercus palustris</i>	Pin Oak
5	<i>Quercus palustris</i>	Pin Oak
6	<i>Quercus palustris</i>	Pin Oak
10	<i>Quercus palustris</i>	Pin Oak
11	<i>Quercus palustris</i>	Pin Oak
12	<i>Quercus palustris</i>	Pin Oak
13	<i>Quercus palustris</i>	Pin Oak

2.3 The balance of trees assessed within the site are of low retention value, Silver Birch located to the periphery of the car park. The low retention value of these trees is a reflection of their overall condition and limited existing and potential amenity value.

TABLE 2 Trees assessed of low retention value

No	Species	Common Name
7	<i>Betula pendula</i>	Silver Birch
8	<i>Betula pendula</i>	Silver Birch
9	<i>Betula pendula</i>	Silver Birch
14	<i>Betula pendula</i>	Silver Birch
15	<i>Betula pendula</i>	Silver Birch
16	<i>Betula pendula</i>	Silver Birch
17	<i>Betula pendula</i>	Silver Birch
18	<i>Betula pendula</i>	Silver Birch

2.4 Trees assessed outside the site are street trees in the Napier Street, Young Street and Victoria Parade road reserves to the east, west and south respectively. Young Street is planted with developing Golden Robinia (Trees 19-25), their overall form reflecting the limited light between tall buildings in this section of Young Street. An older Locust (Tree 26) is located in the south west of the study area within Victoria Parade.

2.5 The west side of Napier Street is planted with a pair of semi-mature Pin Oaks (Trees 27 and 28) located in a roadside bed at the intersection of Victoria Parade, with a row of established Elms (Trees 29-32) planted in roadside cut-outs to the north of the intersection. The Elms are part of a larger avenue plantation that provide a high level of amenity to the streetscape.

TABLE 3 Trees assessed outside the site

No	Species	Common Name
19	<i>Robinia pseudoacacia</i> 'Frisia'	Golden Robinia
20	<i>Robinia pseudoacacia</i> 'Frisia'	Golden Robinia
21	<i>Robinia pseudoacacia</i> 'Frisia'	Golden Robinia
22	<i>Robinia pseudoacacia</i> 'Frisia'	Golden Robinia
23	<i>Robinia pseudoacacia</i> 'Frisia'	Golden Robinia
24	<i>Robinia pseudoacacia</i> 'Frisia'	Golden Robinia
25	<i>Robinia pseudoacacia</i> 'Frisia'	Golden Robinia
26	<i>Robinia pseudoacacia</i>	Locust
27	<i>Quercus palustris</i>	Pin Oak
28	<i>Quercus palustris</i>	Pin Oak
29	<i>Ulmus procera</i>	English Elm
30	<i>Ulmus procera</i>	English Elm
31	<i>Ulmus procera</i>	English Elm
32	<i>Ulmus procera</i>	English Elm

3 IMPACT OF PROPOSED DEVELOPMENT

- 3.1 Development of the site is proposed, including construction of a new 13 level building over basement car park in the existing car parking area. A new vehicular access is proposed from Napier Street, with changes proposed to the road functional layout of Napier Street. The following drawings have been reviewed in the preparation of these notes:

Lyons Architects ACU Development Plan October 2016;

&

Signage and Linemarking Plan. Functional Layout Plan Option 02 CG150178-TR-DG-2502 Rev 3 11.10.2016

Australian Catholic University, Napier Street, Fitzroy. City Of Yarra

Prepared by Cardno

Site Trees

- 3.2 All trees assess within the site will require removal to facilitate development. None are considered to be of sufficiently high value to require redesign to ensure retention.

Trees Outside the Site

- 3.3 Two trees outside the site, a pair of Pin Oaks (Trees 27 and 28) at the south western end of Napier Street will require removal for the revised road functional layout.
- 3.4 The balance of trees to the west side of Napier Street outside the development area can be retained, subject to appropriate protection conforming to AS4970-2009 *Protection of Trees on Development Sites*. The only noted encroachments by works are for :
- The basement, <1% of the tree protection zone of Tree 29.
 - The basement ramp crossover, <= 3% for Tree 30, <1% for Tree 31.
- 3.5 All are minor encroachments under the provisions of AS4970-2009.
- 3.6 The road functional layout has been developed so that new kerb and channel is limited to the crossover within the tree protection zones of trees to be retained, and traffic separation within TPZs can be accomplished with line-marking and surface texturing.
- 3.7 There may be the potential to provide permeability through removal of bituminous concrete to portions of the west side of Napier Street (currently sealed to the kerb) to improve growing conditions for existing trees.

- 3.8 A full survey of all trees is included below.
- 3.9 The location of each tree is shown in 7 Appendix 1 – Tree Location Plan.

4 SITE PHOTOGRAPHS



Figure 1 From right, Trees 2, 3 and 4 in the car park.



Figure 2 Tree 1, a pair of Bangalow Palms .



Figure 3 Tree 32 in the Napier Street road reserve.



Figure 4 Golden Robinias in the Young Street road reserve.

5 RESULTS OF TREE SURVEY

Tree-1		<i>Archontophoenix cunninghamiana</i> , Bangalow Palm	
Origin: Australian native	Type: Evergreen Broadleaf	Age: Semi-mature	
DBH (cm): 16	Height: 10m	Width: 5m	TPZ: 3.5m
Crown class: Symmetrical	Health: Fair-Good	Structure: Fair-Good	SULE: 20years
Amenity value: Medium	Comments: Can be transplanted		
Retention Value: Medium	Reason:		
Impact of Development: Remove			

Tree-2		<i>Quercus palustris</i> , Pin Oak	
Origin: Exotic	Type: Deciduous Broadleaf	Age: Semi-mature	
DBH (cm): 35.5	Height: 13m	Width: 6m	TPZ: 4.3m
Crown class: Symmetrical	Health: Dormant	Structure: Fair-Good	SULE: 20years
Amenity value: Medium	Comments: Good developing specimen		
Retention Value: Medium	Reason:		
Impact of Development: Remove			

Tree-3		<i>Quercus palustris</i> , Pin Oak	
Origin: Exotic	Type: Deciduous Broadleaf	Age: Semi-mature	
DBH (cm): 20.5	Height: 8m	Width: 5m	TPZ: 2.5m
Crown class: Symmetrical	Health: Dormant	Structure: Fair	SULE: 20years
Amenity value: Low	Comments:		
Retention Value: Medium	Reason:		
Impact of Development: Remove			

Tree-4		<i>Quercus palustris</i> , Pin Oak	
Origin: Exotic	Type: Deciduous Broadleaf	Age: Semi-mature	
DBH (cm): 23	Height: 11m	Width: 6m	TPZ: 2.8m
Crown class: Symmetrical	Health: Dormant	Structure: Fair-Good	SULE: 20years
Amenity value: Medium	Comments: Slightly kinked trunk, otherwise good developing specimen		
Retention Value: Medium	Reason:		
Impact of Development: Remove			

Tree-5		<i>Quercus palustris</i> , Pin Oak	
Origin: Exotic	Type: Deciduous Broadleaf	Age: Semi-mature	
DBH (cm): 30	Height: 12m	Width: 6m	TPZ: 3.6m
Crown class: Symmetrical	Health: Dormant	Structure: Fair	SULE: 20years
Amenity value: Medium	Comments:		
Retention Value: Medium	Reason:		
Impact of Development: Remove			

Tree-6		<i>Quercus palustris</i> , Pin Oak	
Origin: Exotic	Type: Deciduous Broadleaf	Age: Semi-mature	
DBH (cm): 31.5	Height: 12m	Width: 7m	TPZ: 3.8m
Crown class: Symmetrical	Health: Dormant	Structure: Fair	SULE: 20years
Amenity value: Medium	Comments: Contorted trunk. Codominant pruned out.		
Retention Value: Medium	Reason:		
Impact of Development: Remove			

Tree-7		<i>Betula pendula</i> , Silver Birch	
Origin: Exotic	Type: Deciduous Broadleaf	Age: Semi-mature	
DBH (cm): 17	Height: 6m	Width: 4m	TPZ: 2.0m
Crown class: Symmetrical	Health: Dormant	Structure: Fair	SULE: 10-20years
Amenity value: Low	Comments:		
Retention Value: Low	Reason:		
Impact of Development: Remove			

Tree-8		<i>Betula pendula</i> , Silver Birch	
Origin: Exotic	Type: Deciduous Broadleaf	Age: Semi-mature	
DBH (cm): 25.5	Height: 10m	Width: 6m	TPZ: 3.1m
Crown class: Symmetrical	Health: Dormant	Structure: Fair	SULE: 10-20years
Amenity value: Medium	Comments: Narrow primary union		
Retention Value: Low	Reason:		
Impact of Development: Remove			

Tree-9		<i>Betula pendula</i> , Silver Birch	
Origin: Exotic	Type: Deciduous Broadleaf	Age: Semi-mature	
DBH (cm): 18	Height: 9m	Width: 6m	TPZ: 2.2m
Crown class: Symmetrical	Health: Dormant	Structure: Fair-Poor	SULE: 0-10years
Amenity value: Low	Comments: Dead wood evident		
Retention Value: Low	Reason:		
Impact of Development: Remove			

Tree-10	<i>Quercus palustris</i> , Pin Oak		
Origin: Exotic	Type: Deciduous Broadleaf	Age: Semi-mature	
DBH (cm): 23.5	Height: 9m	Width: 6m	TPZ: 2.8m
Crown class: Symmetrical	Health: Dormant	Structure: Fair-Good	SULE: 20years
Amenity value: Medium	Comments:		
Retention Value: Medium	Reason:		
Impact of Development: Remove			

Tree-11	<i>Quercus palustris</i> , Pin Oak		
Origin: Exotic	Type: Deciduous Broadleaf	Age: Semi-mature	
DBH (cm): 22.5	Height: 8m	Width: 6m	TPZ: 2.7m
Crown class: Symmetrical	Health: Dormant	Structure: Fair-Good	SULE: 20years
Amenity value: Medium	Comments:		
Retention Value: Medium	Reason:		
Impact of Development: Remove			

Tree-12	<i>Quercus palustris</i> , Pin Oak		
Origin: Exotic	Type: Deciduous Broadleaf	Age: Semi-mature	
DBH (cm): 23.5	Height: 8m	Width: 7m	TPZ: 2.8m
Crown class: Symmetrical	Health: Dormant	Structure: Fair-Good	SULE: 20years
Amenity value: Medium	Comments:		
Retention Value: Medium	Reason:		
Impact of Development: Remove			

Tree-13	<i>Quercus palustris</i> , Pin Oak		
Origin: Exotic	Type: Deciduous Broadleaf	Age:	
DBH (cm): 31	Height: 8m	Width: 7m	TPZ: 3.7m
Crown class: Symmetrical	Health: Dormant	Structure: Fair-Good	SULE: years
Amenity value: Medium	Comments:		
Retention Value: Medium	Reason:		
Impact of Development: Remove			

Tree-14	<i>Betula pendula</i> , Silver Birch		
Origin: Exotic	Type: Deciduous Broadleaf	Age: Senescent	
DBH (cm): 0	Height: 5m	Width: 2m	TPZ: 2.0m
Crown class: Symmetrical	Health: Poor	Structure: Poor	SULE: 0years
Amenity value: Very Low	Comments: Cracks in trunk, possibly dead.		
Retention Value: Low	Reason:		
Impact of Development: Remove			

Tree-15	<i>Betula pendula</i> , Silver Birch		
Origin: Exotic	Type: Deciduous Broadleaf	Age: Semi-mature	
DBH (cm): 13.5	Height: 5m	Width: 2m	TPZ: 2.0m
Crown class: Symmetrical	Health: Dormant	Structure: Fair	SULE: 10-20years
Amenity value: Low	Comments:		
Retention Value: Low	Reason:		
Impact of Development: Remove			

Tree-16	<i>Betula pendula</i> , Silver Birch		
Origin: Exotic	Type: Deciduous Broadleaf	Age: Semi-mature	
DBH (cm): 19.5	Height: 7m	Width: 5m	TPZ: 2.3m
Crown class: Symmetrical	Health: Dormant	Structure: Fair	SULE: 10-20years
Amenity value: Medium	Comments:		
Retention Value: Low	Reason:		
Impact of Development: Remove			

Tree-17	<i>Betula pendula</i> , Silver Birch		
Origin: Exotic	Type: Deciduous Broadleaf	Age: Semi-mature	
DBH (cm): 15	Height: 10m	Width: 4m	TPZ: 2.0m
Crown class: Symmetrical	Health: Dormant	Structure: Fair-Good	SULE: 10-20years
Amenity value: Medium	Comments:		
Retention Value: Low	Reason:		
Impact of Development: Remove			

Tree-18	<i>Betula pendula</i> , Silver Birch		
Origin: Exotic	Type: Deciduous Broadleaf	Age: Semi-mature	
DBH (cm): 20	Height: 10m	Width: 6m	TPZ: 2.4m
Crown class: Asymmetrical	Health: Dormant	Structure: Fair-Good	SULE: 10-20years
Amenity value: Medium	Comments:		
Retention Value: Low	Reason:		
Impact of Development: Remove			

Tree-19	<i>Robinia pseudoacacia</i> 'Frisia', Golden Robinia		
Origin: Exotic weed	Type: Deciduous Broadleaf	Age: Semi-mature	
DBH (cm): 20	Height: 12m	Width: 6m	TPZ: 2.4m
Crown class: Symmetrical	Health: Dormant	Structure: Fair	SULE: 20years
Amenity value: Medium	Comments: Street tree		
Retention Value: Outside property	Reason:		
Impact of Development: Retain			

Tree-20		<i>Robinia pseudoacacia</i> 'Frisia', Golden Robinia	
Origin: Exotic weed	Type: Deciduous Broadleaf	Age: Semi-mature	
DBH (cm): 17.5	Height: 12m	Width: 6m	TPZ: 2.1m
Crown class: Symmetrical	Health: Dormant	Structure: Fair	SULE: 20years
Amenity value: Medium	Comments: Street tree		
Retention Value: Outside property		Reason:	
Impact of Development: Retain			

Tree-21		<i>Robinia pseudoacacia</i> 'Frisia', Golden Robinia	
Origin: Exotic weed	Type: Deciduous Broadleaf	Age: Juvenile	
DBH (cm): <15	Height: 2m	Width: 1m	TPZ: 2.0m
Crown class: Symmetrical	Health: Fair-Good	Structure: Fair-Good	SULE: 20years
Amenity value: Low	Comments: Newly planted Street tree		
Retention Value: Outside property		Reason:	
Impact of Development: Retain			

Tree-22		<i>Robinia pseudoacacia</i> 'Frisia', Golden Robinia	
Origin: Exotic weed	Type: Deciduous Broadleaf	Age: Semi-mature	
DBH (cm): <15	Height: 2m	Width: 1m	TPZ: 2.0m
Crown class: Symmetrical	Health: Dormant	Structure: Fair-Good	SULE: 20years
Amenity value: Low	Comments: Newly planted Street tree		
Retention Value: Outside property		Reason:	
Impact of Development: Retain			

Tree-23		<i>Robinia pseudoacacia</i> 'Frisia', Golden Robinia	
Origin: Exotic weed	Type: Deciduous Broadleaf	Age: Semi-mature	
DBH (cm): 13	Height: 12m	Width: 7m	TPZ: 2.0m
Crown class: Symmetrical	Health: Dormant	Structure: Fair	SULE: 20years
Amenity value: Low	Comments: Street tree		
Retention Value: Outside property		Reason:	
Impact of Development: Retain			

Tree-24		<i>Robinia pseudoacacia</i> 'Frisia', Golden Robinia	
Origin: Exotic weed	Type: Deciduous Broadleaf	Age: Semi-mature	
DBH (cm): 23	Height: 12m	Width: 7m	TPZ: 2.8m
Crown class: Symmetrical	Health: Dormant	Structure: Fair-Good	SULE: 20years
Amenity value: Medium	Comments: Street tree		
Retention Value: Outside property		Reason:	
Impact of Development: Retain			

Tree-25		<i>Robinia pseudoacacia</i> 'Frisia', Golden Robinia	
Origin: Exotic weed	Type: Deciduous Broadleaf	Age: Semi-mature	
DBH (cm): 30	Height: 12m	Width: 7m	TPZ: 3.6m
Crown class: Symmetrical	Health: Dormant	Structure: Fair	SULE: 0-10years
Amenity value: Medium	Comments: Basal trunk canker and frass. Street tree		
Retention Value: Outside property		Reason:	
Impact of Development: Retain			

Tree-26		<i>Robinia pseudoacacia</i> , Locust	
Origin: Exotic weed	Type: Deciduous Broadleaf	Age: Semi-mature	
DBH (cm): 19.5	Height: 6m	Width: 5m	TPZ: 2.3m
Crown class: Symmetrical	Health: Fair	Structure: Fair	SULE: 10-20years
Amenity value: Medium	Comments: Fungal bodies on trunk. Street tree		
Retention Value: Outside property		Reason:	
Impact of Development: Retain			

Tree-27		<i>Quercus palustris</i> , Pin Oak	
Origin: Exotic	Type: Deciduous Broadleaf	Age: Semi-mature	
DBH (cm): 32	Height: 10m	Width: 9m	TPZ: 3.8m
Crown class: Symmetrical	Health: Dormant	Structure: Fair	SULE: 20years
Amenity value: Medium	Comments: Canyon pruned.		
Retention Value: Outside property		Reason:	
Impact of Development: Remove			

Tree-28		<i>Quercus palustris</i> , Pin Oak	
Origin: Exotic	Type: Deciduous Broadleaf	Age: Semi-mature	
DBH (cm): 34	Height: 13m	Width: 10m	TPZ: 4.1m
Crown class: Intermediate	Health: Dormant	Structure: Fair	SULE: 20years
Amenity value: Medium	Comments: Canyon pruned and asymmetric		
Retention Value: Outside property		Reason:	
Impact of Development: Remove			

Tree-29		<i>Ulmus procera</i> , English Elm	
Origin: Exotic	Type: Deciduous Broadleaf	Age: Semi-mature	
DBH (cm): 34	Height: 13m	Width: 10m	TPZ: 4.1m
Crown class: Symmetrical	Health: Dormant	Structure: Fair-Good	SULE: 20years
Amenity value: High	Comments: Basal wounding.		
Retention Value: Outside property		Reason:	
Impact of Development: Retain			

Tree-30	<i>Ulmus procera</i>, English Elm		
Origin: Exotic	Type: Deciduous Broadleaf	Age: Semi-mature	
DBH (cm): 29	Height: 12m	Width: 6m	TPZ: 3.5m
Crown class: Symmetrical	Health: Dormant	Structure: Fair	SULE: 10-20years
Amenity value: High	Comments: Large tear-out wound east side.		
Retention Value: Outside property	Reason:		
Impact of Development: Retain			
Tree-31	<i>Ulmus procera</i>, English Elm		
Origin: Exotic	Type: Deciduous Broadleaf	Age: Semi-mature	
DBH (cm): 36.5	Height: 13m	Width: 7m	TPZ: 4.4m
Crown class: Symmetrical	Health: Dormant	Structure: Fair	SULE: 20years
Amenity value: Medium	Comments: Lost co-dominant. Trunk wounding.		
Retention Value: Outside property	Reason:		
Impact of Development: Retain			
Tree-32	<i>Ulmus procera</i>, English Elm		
Origin: Exotic	Type: Deciduous Broadleaf	Age: Semi-mature	
DBH (cm): 33	Height: 11m	Width: 7m	TPZ: 4.0m
Crown class: Symmetrical	Health: Dormant	Structure: Fair	SULE: 20years
Amenity value: High	Comments: Some trunk wounds		
Retention Value: Outside property	Reason:		
Impact of Development: Retain			

6 DESCRIPTORS

Tree Number: Refers to location of tree as per the plan at Appendix 1.

Botanical Name: Botanical name of species, based on nomenclature and spelling used by Spencer in *Horticultural Flora of South Eastern Australia* (vols 1-5). Where *Eucalyptus spp.* are not found in this source, nomenclature is based on *Euclid: Eucalypts of Australia* (2006). Eucalypt subspecies information is also based on this source.

While accurate tree identification is attempted, and uncertainties are indicated, some inaccuracies in tree identification may still be present – especially in certain, difficult to determine, genera (e.g. *Cotoneaster* and *Ulmus*) and with cultivars which can have similar characteristics.

Where a doubt as to exact species is indicated, the common name and origin are based on the listed species, and would change if the species were found to be incorrect.

From time to time taxonomists revise plant classification, and name changes are assigned. If it is known names have been revised post the publication of the relevant above listed source, the new nomenclature has been used.

Common Name: Common names are based primarily on names and spelling used by Spencer in *Horticultural Flora of South Eastern Australia* (vols 1-5). The source of common names is taken in the following order:

1. Single name supplied in *Horticultural Flora of South Eastern Australia*;
2. First in list of names supplied in *Horticultural Flora of South Eastern Australia*, unless another name in the list is deemed more appropriate;
3. As per name supplied in *Trees of Victoria and Adjoining Areas*;
4. Then by best known common name if not available in either source.

Common names are provided for thoroughness; the botanical name should be used when referring to the tree taxon.

Origin: **Exotic:** Tree origin is from outside the Australian mainland, Tasmania or near islands.

Australian Native: Origin is from within the Australian mainland or near islands, but outside Victoria.

Victorian Native: Origin is from within Victoria but outside the Melbourne region. This includes trees whose native range extends beyond Victoria into other states.

Melbourne: Origin is from within Melbourne, as defined by plants listed in the *Flora of Melbourne*. This includes trees also found outside Melbourne, and those only within the area at the far extent of their range.

Locally Indigenous: Tree's range includes the local area.

Weed: Trees known to show tendencies to weediness within Victoria. Based on the City of Knox weed list, Department of Primary Industries (Victoria) weed list and past experience. Trees with the addition of "(nox.*)" indicate a declared noxious weed; refer to the Department of Primary Industries website for further information.

Type:

Broadleaf: Tree is a dicotyledon flowering plant.

Conifer: Tree is a cone bearing non-flowering plant.

Palm: Tree is a monocotyledon Palm (that is *Arecaceae*).

Palm Like: Tree is a monocotyledon, but is not a palm (that is not *Arecaceae*).

Deciduous: Tree seasonally loses its leaves in Victoria.

Evergreen: Tree maintains its leaves throughout the year.

Semi-deciduous: Tree may or may not lose its leaves, or may only partially lose them.

Age:

Juvenile: Tree is actively growing and is still in its establishment phase. Tree currently makes little contribution to the amenity of the landscape. Trees of this age are possible candidates for relocation during development.

Semi-mature: Tree is still actively growing but has reached an age and size where it is starting to make a contribution to the landscape.

The size of the tree would still be expected to increase considerably given no significant changes to the current situation.

Mature: Tree growth has slowed, and the size of the tree would not be expected to increase considerably without significant changes to the current situation (e.g. vegetation removal). Tree is not exhibiting any major signs of health or structural weakness as a result of age.

Over mature: Tree is no longer actively putting out extension growth, and is starting to show decline in health or structural stability as a result of age.

Senescent: Tree is senescing. Trees in this category may not be especially large or old, but are reaching the end of their expected life, often indicated by extreme poor health.

Height:

Estimate of the tree's height in metres

DBH:

The tree's trunk Diameter at Breast Height (1.4m above ground) unless specified as having been taken lower. This can be either estimated or measured as specified in the report.

Stems of multi-stemmed trees may be listed individually, or a measurement given at a lower point where the tree still has one stem. In some cases, especially where trees are not considered worthy of retention or stems are too numerous the DBH may simply be listed as "multi-stemmed".

Health:

The tree's health is rated as **Good**, **Fair** and **Poor** as listed below. Tree ratings of **Fair-Good** and **Fair-Poor** indicate that the tree falls between the two categories. Dead trees are not given a rating, but are listed as **Dead**.

Ratings generally meet the following descriptions:

Good: *Tree is showing no obvious signs of poor health or stress with a dense canopy that is free of dieback. Rot or pathogens are not obvious or are not considered to be a threat to the tree. Growth rates are acceptable.*

Fair: *Tree is showing signs of reduced health or stress.* This is apparent through moderate foliage density, minor dieback, moderate stress response growth, minor to moderate rot, moderate pathogen infestation, stunted growth or a combination of the above symptoms.

Poor: *Tree is showing signs of poor health and/or severe stress.* This is apparent through either low foliage density, moderate to large-scale dieback, severe stress response growth, severe rot, severe pathogen infestation, failure of wounds to heal, overall tree decline or a combination of the above symptoms.

Note on Deciduous Species: Assessment of deciduous species can be problematic and results may vary depending on the time of year of assessment. Descriptor comments in relation to foliage density do not apply to deciduous trees assessed when dormant or entering or exiting dormancy. Time of leaf drop or bud burst and extent of bud swell may be considered in the health rating of these trees.

The ratings indicate that certain characteristics listed have, or have not been observed. Inspections do not assess the whole tree in detail for each characteristic. The comments category should be referred to for further information.

Structure:

The tree's structure is rated as **Good**, **Fair** and **Poor**. Tree ratings of **Fair-Good** and **Fair-Poor** indicate that the tree falls between the two categories.

As a general rule, the structure rating is based on the tree's likelihood of failure. However, it must be noted that this is not a full hazard or failure assessment of the tree.

Good: Tree has no obvious structural defects and is therefore not considered likely to fail.

Fair: Tree has at least one obvious structural defect, but this is considered to be manageable and of only moderate failure risk or the piece likely to fail may be small. Structural defects that may contribute to a fair rating are as follows:

- Poor branch attachment (including deadwood and large epicormics);
- Bifurcated, but with a join that is considered to be solid;
- Moderate trunk lean but without other defects;
- Minor damage to the trunk base;
- Rot or other damage starting to compromise the structure;
- History of shedding minor branches.

Poor: Tree has at least one structural defect that is severe and considered to have a relatively high risk of failure. If targets are present then defect(s) require treatment, or alternatively the tree should be removed. In some cases removal may be the only option for these trees. Structural defects that may contribute to a poor rating are as follows:

- Poor branch attachment (including deadwood and large epicormics);
- Bifurcated with swelling and/or included bark;
- Severe trunk lean associated with other defects such as injury in the plane of lean or root plate lift;
- Major damage to the trunk base or root system;
- Rot or other damage severely compromising the structure;
- History of shedding large branches.

The ratings indicate that certain characteristics listed have, or have not been observed. Inspections do not assess the whole tree in intense detail for each characteristic. The comments category should be referred to for further information.

Crown class:

Symmetrical: For the most part canopy received light from all four sides and has to potential for even foliage distribution. Canopy may or may not be symmetrical, but is not suppressed.

Asymmetrical: Canopy is shaded or suppressed with one or more sides and dominant when compared to the remainder of the tree. Also includes crowns damaged by previous shading.

Intermediate: Canopy is only receiving light from top, and while shape may be even the upper portions of the canopy dominate over the lower.

Suppressed: Canopy is completely shaded by surrounding vegetation, buildings etc.

Regrowth: Canopy comprised of regrowth. This can be from the base, but also includes branches covered with small, stress related epicormics.

Trained: Canopy has been specifically trained. This may include trees that are pollarded, coppiced or espaliered.

Trees may exhibit a combination of the characteristics above (e.g. a symmetrical canopy of basal regrowth), or may fall between two categories. The characteristic listed is considered to be the best fit at the time.

Amenity value:

Very Low: Tree makes little or no contribution to the amenity value of the site or surrounding area. In some cases the tree may be detrimental to the area's amenity value (e.g. unsightly, risk of weed spread).

Low: Tree makes some contribution to the amenity value of the site, but makes no contribution to the amenity value of the surrounding area. Removal of the tree would result in little loss of amenity. Juvenile trees (including street trees) are generally included in this category, however they may have the potential to supply increased amenity in the future.

Medium: Tree makes a moderate contribution to the amenity of the site and/or may contribute to the amenity of the surrounding area.

High: Tree makes a significant contribution to the amenity value of the site, or tree makes a moderate to significant contribution to the amenity vale of the larger landscape.

The amenity value rating considers the impact the tree has on any neighbouring sites as being of equal importance to that supplied to the

subject site. However, trees that contribute to the amenity of the general area (e.g. streetscape) are given greater weight.

Comments:

Any additional comments in relation to the above categories.

SULE:

The Safe, Useful, Life Expectancy of the tree from a health, structure, amenity and weediness viewpoint given no significant changes to the current situation. This category is difficult to determine, and should be taken as an estimate only, in addition to this, factors not observed at the time of inspection can lead to tree decline.

0: Tree is a hazard or a weed and should be removed immediately.

0-10: Estimated SULE of less than 10 years.

10-20: Estimated SULE of 10 to 20 years.

20: Estimated SULE of 20 years or greater.

Recommendation:

Remove: Tree is either not worthy of retention or requires removal (e.g. weed species).

Retain or Remove: Tree does not require removal, but is of low retention value.

Retain if practical: Tree has a moderate retention value and should be retained if possible during any development of the site.

Notes:

Dead: Tree is dead and should therefore be removed.

Good condition: Tree is worthy of retention based on its condition. Trees may still have some structural or health problems, but are generally worth retaining.

Good development potential: Tree is of a small size, but is considered to have a high potential to develop well. Retention of these trees should be considered as they should develop more quickly than new plantings.

Hazardous: Tree should be removed as it is hazardous.

Heritage tree: Tree is of heritage significance. Refer to the introduction for further information on any trees of heritage significance.

High landscape contribution: Tree is worthy of retention based on its contribution to the site or landscape (associated with amenity value).

Inappropriate location: The tree is not in an appropriate location for its species, size etc. Includes trees too large for their current location.

Juvenile – simple to replace: Tree does not have a high retention value as a similarly sized replacement specimen could be obtained. Alternatively, the tree is a candidate for relocation.

Limited life expectancy: Tree is in decline, or is expected to start to decline within a relatively short time period. As a result, it is not sensible to implement extensive tree protection measures to save the tree unless there are extenuating circumstances (e.g. outside ownership).

Low Amenity Value: Tree is unsightly, or has little potential to add to site amenity (e.g. a non-canopy fruit tree).

Outside ownership: Tree is located outside the subject site, and is therefore owned by another party. The tree may be in a neighbouring private property or fall within the council managed nature strip/road reserve.

It is assumed that the owner of the tree wishes to retain it, and the trees are listed as retain for that reason. The owner should be contacted for discussions if the removal of the tree is wanted. Recommendation of retention of any of these trees is based solely on the above mentioned reason, and is no indication of the tree's general worthiness for retention.

Poor condition: Tree's poor condition makes it unworthy of retention.

Rare / unusual species: Tree is of a species, cultivar or form (trained or otherwise) which is unusual, at least in the local area, and which has some retention value (usually amenity value). Trees of this nature may also classify as a "heritage tree".

Remnant Indigenous: The tree is a remnant indigenous specimen and therefore has environmental value. Trees of this nature, in reasonable condition are usually recommended for retention.

Senescent: Tree should be removed as it is dying.

Significant tree: The tree has been declared a significant tree by the local council, and retention is likely to be a permit requirement.

Unlikely to develop well: Tree is immature with a severe defect which will prevent its form developing as it should or tree has a severe defect, the correction of which will result in a tree shape that is unlikely to redevelop well .

Weed species: Tree should be removed due to weedy nature of the species.

TPZ: The Tree Protection Zone of the tree, measured as a radial distance in metres from the centre of the trunk. The TPZ is calculated using the method specified in *Australian Standard AS4970-2009 Protection of trees on development sites*.

TPZs are not listed for trees that are recommended for removal.

7 APPENDIX 1 – TREE LOCATION PLAN

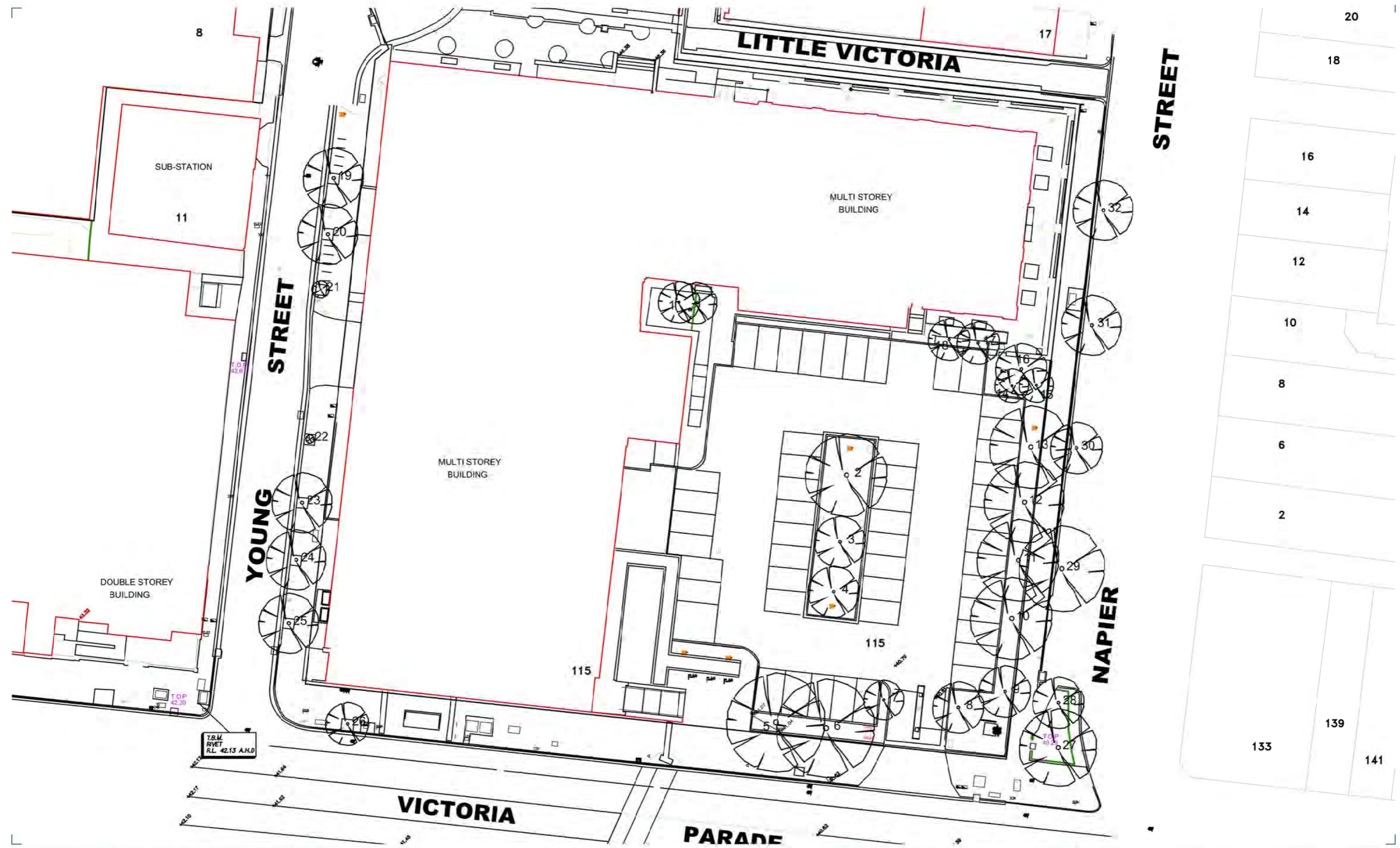

JOHN PATRICK
LANDSCAPE ARCHITECTS PTY LTD
324 Victoria Street,
Richmond, VIC 3121
T +61 3 9429 4855
F +61 3 9429 8211
admin@johnpatrick.com.au
www.johnpatrick.com.au

COPYRIGHT
This drawing must not be copied in whole
or in part without the consent of John
Patrick Landscape Architects Pty Ltd
Do not scale off drawings

CLIENT
Avium Projects P/L

PROJECT
Tree Survey
Australian Catholic University
Fitzroy Campus

DRAWING
Tree Location Plan

SCALE 1:400 @ A3
DATE OCT 2016
DRAWN SH
CHECKED
JOB NO 16-794
DWG NO 16-794TS-01



Sydney

Tower 2, Level 23, Darling Park
201 Sussex Street
Sydney, NSW 2000
Tel: +612 8233 9900
Fax: +612 8233 9966

Brisbane

Level 7, 123 Albert Street
Brisbane, QLD 4000
Tel: +617 3007 3800
Fax: +617 3007 3811

Melbourne

Level 12, 120 Collins Street
Melbourne, VIC 3000
Tel: +613 8663 4888
Fax: +613 8663 4999

Perth

Level 1, 55 St Georges Terrace
Perth, WA 6000
Tel: +618 9346 0500
Fax: +618 9221 1779

Australia · Asia · Middle East
www.urbis.com.au
info@urbis.com.au